



MOTOROLA

START HERE >

Welcome

Welcome to the world of Motorola digital wireless communications! We are pleased that you have chosen the Motorola T730 CDMA wireless phone.

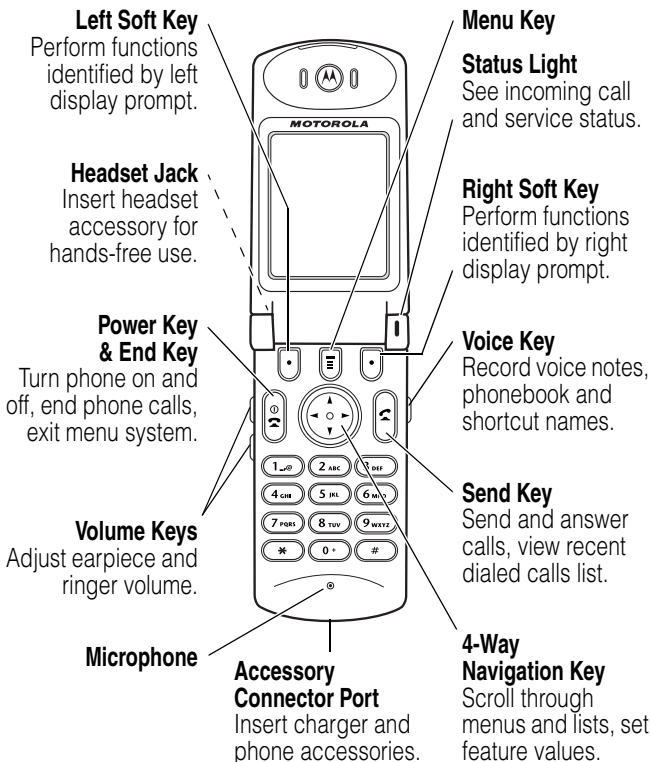

Motorola, Inc.
Consumer Advocacy Office
1307 East Algonquin Road
Schaumburg, IL 60196
1-800-331-6456 (United States)
1-888-390-6456 (TTY/TDD United States)
1-800-461-4575 (Canada)

www.motorola.com (United States)
www.motorola.ca (Canada)

MOTOROLA and the Stylized M Logo are registered in the US Patent & Trademark Office. All other product or service names are the property of their respective owners.

© Motorola, Inc. 2002, 2003.

Software Copyright Notice

The Motorola products described in this manual may include copyrighted Motorola and third-party software stored in semiconductor memories or other media. Laws in the United States and other countries preserve for Motorola and third-party software providers certain exclusive rights for copyrighted software, such as the exclusive rights to distribute or reproduce the copyrighted software. Accordingly, any copyrighted software contained in the Motorola products may not be modified, reverse-engineered, distributed, or reproduced in any manner to the extent allowed by law. Furthermore, the purchase of the Motorola products shall not be deemed to grant either directly or by implication, estoppel, or otherwise, any license under the copyrights, patents, or patent applications of Motorola or any third-party software provider, except for the normal, non-exclusive, royalty-free license to use that arises by operation of law in the sale of a product.

Manual number: 6809472A32-O
Cover number: 8988485L61-O

Contents

Safety and General Information	6
Getting Started	12
What's in the Box?	12
About This Guide	12
Installing the Battery	13
Charging the Battery	14
Battery Use	15
Changing the Convertible Covers	17
Turning Your Phone On	18
Adjusting Volume	19
Making a Call	19
Answering a Call	20
Changing the Call Alert	20
Viewing Your Phone Number	20
Learning to Use Your Phone	21
Using the Display	21
Using the 4-Way Navigation Key	25
Using Menus	26
Entering Text	31
Using the Status Light	39
Using the External Display	40
Locking and Unlocking Your Phone	40
Changing a Code or Password	41
If You Forget a Code or Password	42
Setting Up Your Phone	43
Storing Your Name and Phone Number	43
Setting the Time and Date	43
Setting a Ring Style	43

Setting Answer Options	44
Setting a Wallpaper Image	44
Setting a Screen Saver Image	46
Zooming In and Out	47
Setting Display Contrast	47
Setting Display Color	47
Adjusting the Backlight	47
Hiding or Showing Location Information	48
Calling Features	49
Changing the Active Line	49
Redialing a Number	49
Using Automatic Redial	49
Using Caller ID	50
Canceling an Incoming Call	51
Turning Off a Call Alert	51
Calling an Emergency Number	51
Viewing Recent Calls	52
Returning an Unanswered Call	54
Using the Notepad	54
Attaching a Number	55
Calling With Speed Dial	56
Calling With One-Touch Dial	56
Using Voicemail	57
Muting the Phone	58
Using Call Waiting	58
Phone Features	59
Main Menu	59
Feature Quick Reference	61
Specific Absorption Rate Data	70
Consumer Information on Wireless Phones from the FDA	72

Warranty	77
Product Registration	82
Export Law Assurances	82
RF Energy Interference	82
Index	83
Wireless Phone Safety Tips	91

Safety and General Information

IMPORTANT INFORMATION ON SAFE AND EFFICIENT OPERATION.
READ THIS INFORMATION BEFORE USING YOUR PHONE.

The information provided in this document supersedes the general safety information in user guides published prior to December 1, 2002.

Exposure To Radio Frequency (RF) Energy

Your phone contains a transmitter and a receiver. When it is ON, it receives and transmits RF energy. When you communicate with your phone, the system handling your call controls the power level at which your phone transmits.

Your Motorola phone is designed to comply with local regulatory requirements in your country concerning exposure of human beings to RF energy.

Operational Precautions

To assure optimal phone performance and make sure human exposure to RF energy is within the guidelines set forth in the relevant standards, always adhere to the following procedures.

External Antenna Care

Use only the supplied or Motorola-approved replacement antenna. Unauthorized antennas, modifications, or attachments could damage the phone.

Do NOT hold the external antenna when the phone is IN USE. Holding the external antenna affects call quality and may cause the phone to operate at a higher power level than needed. In addition, use of unauthorized antennas may result in non-compliance with the local regulatory requirements in your country.

Phone Operation

When placing or receiving a phone call, hold your phone as you would a wireline telephone.

Body-Worn Operation

To maintain compliance with RF energy exposure guidelines, if you wear a phone on your body when transmitting, always place the phone in a Motorola-supplied or approved clip, holder, holster, case, or body harness for this phone, if available. Use of accessories not approved by Motorola may exceed RF energy exposure guidelines. If you do not use one of the body-worn accessories approved or supplied by Motorola, and are not using the phone held in the normal use position, ensure the phone and its antenna are at least 1 inch (2.5 centimeters) from your body when transmitting.

Data Operation

When using any data feature of the phone, with or without an accessory cable, position the phone and its antenna at least 1 inch (2.5 centimeters) from your body.

Approved Accessories

Use of accessories not approved by Motorola, including but not limited to batteries and antenna, may cause your phone to exceed RF energy exposure guidelines. For a list of approved Motorola accessories, visit our website at www.Motorola.com.

RF Energy Interference/Compatibility

Note: Nearly every electronic device is susceptible to RF energy interference from external sources if inadequately shielded, designed, or otherwise configured for RF energy compatibility. In some circumstances your phone may cause interference.

Facilities

Turn off your phone in any facility where posted notices instruct you to do so. These facilities may include hospitals or health care facilities that may be using equipment that is sensitive to external RF energy.

Aircraft

When instructed to do so, turn off your phone when on board an aircraft. Any use of a phone must be in accordance with applicable regulations per airline crew instructions.

Medical Devices

Pacemakers

Pacemaker manufacturers recommend that a minimum separation of 6 inches (15 centimeters) be maintained between a handheld wireless phone and a pacemaker.

Persons with pacemakers should:

- ALWAYS keep the phone more than 6 inches (15 centimeters) from your pacemaker when the phone is turned ON.
- NOT carry the phone in the breast pocket.
- Use the ear opposite the pacemaker to minimize the potential for interference.
- Turn OFF the phone immediately if you have any reason to suspect that interference is taking place.

Hearing Aids

Some digital wireless phones may interfere with some hearing aids. In the event of such interference, you may want to consult your hearing aid manufacturer to discuss alternatives.

Other Medical Devices

If you use any other personal medical device, consult the manufacturer of your device to determine if it is adequately shielded from RF energy. Your physician may be able to assist you in obtaining this information.

Use While Driving

Check the laws and regulations on the use of phones in the area where you drive. Always obey them.

When using your phone while driving, please:

- Give full attention to driving and to the road.
- Use hands-free operation, if available.
- Pull off the road and park before making or answering a call if driving conditions so require.

Responsible driving best practices may be found in the “Wireless Phone Safety Tips” at the end of this manual and at the Motorola website:

www.Motorola.com/callsmart.

Operational Warnings

For Vehicles With an Air Bag

Do not place a phone in the area over an air bag or in the air bag deployment area. Air bags inflate with great force. If a phone is placed in the air bag deployment area and the air bag inflates, the phone may be propelled with great force and cause serious injury to occupants of the vehicle.

Potentially Explosive Atmospheres

Turn off your phone prior to entering any area with a potentially explosive atmosphere, unless it is a phone type especially qualified for use in such areas and certified as “Intrinsically Safe.” Do not remove, install, or charge batteries in such areas. Sparks in a potentially explosive atmosphere can cause an explosion or fire resulting in bodily injury or even death.

Note: The areas with potentially explosive atmospheres referred to above include fueling areas such as below decks on boats, fuel or chemical transfer or storage facilities, areas where the air contains chemicals or particles, such as grain, dust, or metal powders. Areas with potentially explosive atmospheres are often but not always posted.

Blasting Caps and Areas





To avoid possible interference with blasting operations, turn OFF your phone when you are near electrical blasting caps, in a blasting area, or in

areas posted “Turn off electronic devices.” Obey all signs and instructions.

Batteries

Batteries can cause property damage and/or bodily injury such as burns if a conductive material such as jewelry, keys, or beaded chains touch exposed terminals. The conductive material may complete an electrical circuit (short circuit) and become quite hot. Exercise care in handling any charged battery, particularly when placing it inside a pocket, purse, or other container with metal objects. **Use only Motorola original batteries and chargers.**

Your battery or phone may contain symbols, defined as follows:

Symbol	Definition
	Important safety information will follow.
	Your battery or phone should not be disposed of in a fire.
	Your battery or phone may require recycling in accordance with local laws. Contact your local regulatory authorities for more information.
	Your battery or phone should not be thrown in the trash.
	Your phone contains an internal lithium ion battery.

Seizures/Blackouts

Some people may be susceptible to epileptic seizures or blackouts when exposed to blinking lights, such as when watching television or playing video games. These seizures or blackouts may occur even if a person never had a previous seizure or blackout.

If you have experienced seizures or blackouts, or if you have a family history of such occurrences, please consult with your doctor before

playing video games on your phone or enabling a blinking-lights feature on your phone. (The blinking-light feature is not available on all products.)

Parents should monitor their children's use of video game or other features that incorporate blinking lights on the phones. All persons should discontinue use and consult a doctor if any of the following symptoms occur: convulsion, eye or muscle twitching, loss of awareness, involuntary movements, or disorientation.

To limit the likelihood of such symptoms, please take the following safety precautions:

- Do not play or use a blinking-lights feature if you are tired or need sleep.
- Take a minimum of a 15-minute break hourly.
- Play in a room in which all lights are on.
- Play at the farthest distance possible from the screen.

Repetitive Motion Injuries

When you play games on your phone, you may experience occasional discomfort in your hands, arms, shoulders, neck, or other parts of your body. Follow these instructions to avoid problems such as tendonitis, carpal tunnel syndrome, or other musculoskeletal disorders:

- Take a minimum 15-minute break every hour of game playing.
- If your hands, wrists, or arms become tired or sore while playing, stop and rest for several hours before playing again.
- If you continue to have sore hands, wrists, or arms during or after play, stop playing and see a doctor.

Getting Started



What's in the Box?

Your digital wireless phone typically comes equipped with a battery and a charger. You can purchase other accessory items to customize your phone for maximum performance and portability.

To purchase Motorola Original™ accessories, contact the Motorola Customer Call Center at 1-800-331-6456 in the United States or 1-800-461-4575 in Canada.

About This Guide

This guide introduces you to your Motorola wireless phone.

Note: A *More Here* reference guide for your phone is also available that describes your phone's features in more detail.

To obtain the *More Here* guide for your phone, or another copy of this guide, see the Motorola Web site at:

<http://motorola.com/consumer/manuals> (U.S.A.)

<http://motorola.ca/consumer> (Canada)

or contact the Motorola Customer Call Center at 1-800-331-6456 in the United States or 1-800-461-4575 in Canada.

Optional Features



This label identifies an optional network or subscription-dependent feature that may not be offered by all service providers in all geographical areas. Contact your service provider for more information.



Optional Accessories



This label identifies a feature that requires an optional Motorola Original™ accessory.

Installing the Battery

You must install and charge the battery to use your phone.



Your phone is designed to be used only with Motorola Original batteries and accessories. We recommend that you store batteries in their protective cases when not in use.

Action

- 1 Remove the battery from its protective clear plastic case.
- 2 If necessary, slide down the battery door release latch and lift the door off of the phone.

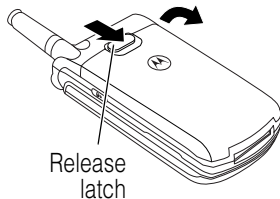

Action

- 3** Insert the battery, printed arrow first, **under the tabs** at the bottom of the battery compartment and push down.

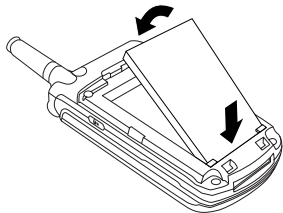

- 4** Insert the teeth at the bottom of the battery door into the slot at the base of the phone, then push the door down. Slide the release latch up to lock the door in place.

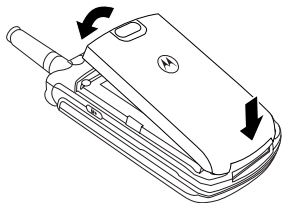

Charging the Battery

New batteries are shipped partially charged. Before you can use your phone, you need to install and charge the



battery as described below. Some batteries perform best after several full charge/discharge cycles.

Action

- 1 Plug the travel charger into your phone with the release tab facing up.

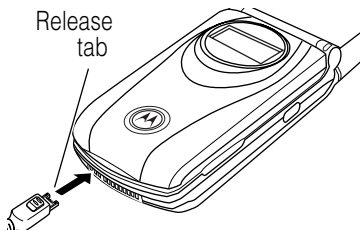

- 2 Plug the other end of the travel charger into the appropriate electrical outlet.
- 3 When your phone indicates that the battery is fully charged (**Charge Complete**), press the release tab and remove the travel charger.

Note: When you charge the battery, the battery level indicator in the upper right corner of the display shows how much of the charging process is complete. At least one segment of the battery level indicator must be visible to ensure full phone functionality while charging.

Battery Use

Battery performance depends on many factors, including your wireless carrier's network configuration; signal strength; the temperature at which you operate your phone; the features and/or settings you select and use; items attached to the phone's accessory connector port; and your voice, data, and other application usage patterns.



Caution: To prevent injuries or burns, do not allow metal objects to contact or short-circuit the battery terminals.

To maximize your battery's performance:

- Always use Motorola Original™ batteries and battery chargers. The phone warranty does not cover damage caused from using non-Motorola batteries and/or battery chargers.
- New batteries or batteries that have been stored for long periods of time may require a longer charge time.
- Maintain the battery at or near room temperature when charging.
- Do not expose batteries to temperatures below -10°C (14°F) or above 45°C (113°F). Always take your phone with you when you leave your vehicle.
- When you do not intend to use a battery for a while, store it uncharged in a cool, dark, dry place, such as a refrigerator.
- Over extended periods of time, batteries gradually wear down and require longer charging times. This is normal. If you charge your battery regularly and notice a decrease in talk time or an increase in charging time, then it is probably time to purchase a new battery.



The rechargeable batteries that power this product must be disposed of properly and may need to be recycled. Refer to your battery's label for battery type. Contact your local recycling center for proper disposal methods. Never dispose of batteries in a fire because they may explode.

Changing the Convertible Covers



You can change the flip cover and battery cover on your phone to personalize its appearance. Matching front and back cover sets are available in a variety of colors and

designs.

Your phone is designed to be used only with Motorola Original accessories. See your Motorola retailer for these convertible covers.

Removing a Flip Cover

Action

Insert your fingertip or fingernail into the slot at the base of the flip cover, then **firmly** pull up and lift the cover off the phone

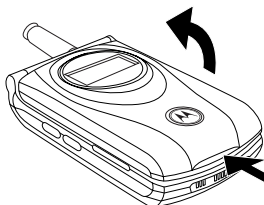

Notes:

- Do not use tools to remove a flip cover. Using tools to remove a flip cover will damage the cosmetic appearance of the phone.
- The flip cover is attached tightly to the phone, and considerable force is required to remove it.



Attaching a Flip Cover



Action

Insert the tabs at the bottom of the cover into the slots at the base of the phone, then push the cover down and snap it into place.

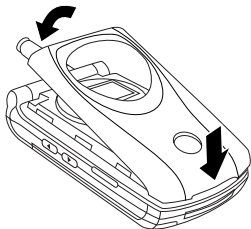

Turning Your Phone On

Action

- 1 Open your phone
- 2 Press and hold  for three seconds to turn on the phone

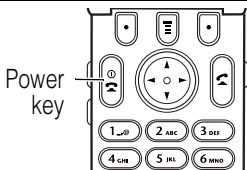

- 3 If necessary, enter your four-digit unlock code and press **OK** () to unlock the phone

The unlock code is originally set to 1234. Your service provider may change this number before you receive your phone.

Adjusting Volume

Press the up and down volume keys to:

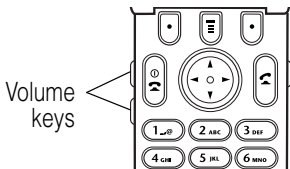

- increase and decrease earpiece volume during a call
- increase and decrease the ringer volume setting when the idle display is visible (flip must be open)

Tip: At the lowest volume setting, press the down volume key to switch to silent alert. Press the up volume key to reset ring alert.

- turn off an incoming call alert

Making a Call

Action

- 1 Extend the antenna
- 2 Press the keypad keys to dial the phone number

Tip: If you make a mistake, press **DELETE** (⏏) to delete the last digit, or press and hold **DELETE** (⏏) to clear all digits.

- 3 Press (☎) to make the call
- 4 Press (⏏) to end the call and “hang up” the phone when you are finished



Note: You must dial the phone number from the idle display. See page 21.



Answering a Call

When you receive a call, your phone rings and/or vibrates and displays an incoming call message.



Press	To
1  or ANSWER ()	answer the call
2 	end the call and “hang up” the phone when you are finished

Tip: When the phone flip is active, simply open the phone to answer the call. (To activate, press  > **Settings** > **In-Call Setup** > **Answer Options** > **Open to Answer**)



Note: If the phone is locked, you must unlock it to answer the call.

Changing the Call Alert

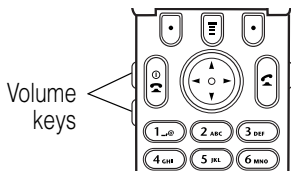
With the phone flip open, press the down volume key to switch the alert for incoming calls and other events to silent alert. Press the up volume key to reset ring alert.



Viewing Your Phone Number

To view your phone number from the idle display, press  .

While you are on a call, press  > **My Tel. Numbers**.

Learning to Use Your Phone

See page 1 for a basic phone diagram.



Using the Display

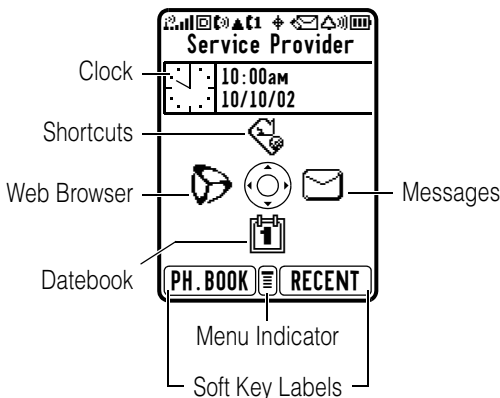

The *idle display* (shown below) is the standard display you see when you are *not* on a call or using the menu. You must be in the idle display to dial a phone number.



Press the 4-way navigation key (⊕) left, right, up, or down to select one of the four menu feature icons in the idle display.



The  (menu) indicator at the bottom center of the display indicates you can press the menu key () to go to the main menu to see more features.

Labels at the bottom corners of the display show the current soft key functions. Press the left soft key () or right soft key () to perform the function indicated by the left or right soft key label.

Status indicators are grouped at the top of the display:

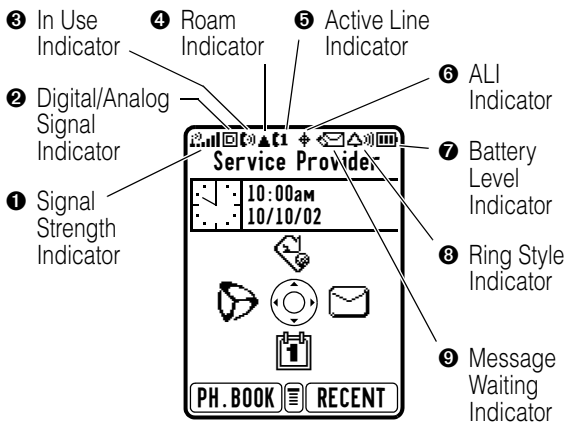

1 Signal Strength Indicator Vertical bars show the strength of the network connection. You cannot make or receive calls when the  (no signal) indicator is displayed.



2 Digital/Analog Signal Indicator Shows whether you are receiving a digital or analog signal:

 = digital signal

 = analog signal

 = 13K digital

 = 8K digital

 = packet data service

③ In Use Indicator Shows that a call is in progress. Other indicators can include:

 = secure CSD call

 = unsecure CSD call

 = secure packet data transfer

 = unsecure packet data transfer

 = secure application connection

 = unsecure application connection



④ Roam Indicator Shows that your phone is seeking or using another network system outside your home network.

 = 3G roam

 = 3G home

 = 2G roam

 = 2G home

On text entry screens, shows text entry status information:

 = symbol mode

 = numeric mode

 = caps lock on

 = normal text entry



⑤ Active Line Indicator Shows the current active phone line:

 = line 1

 = line 2





6 ALI Indicator Shows the status of the *automatic location information* feature:

☎ = ALI on

☎ = ALI off

On text entry screens, shows text entry status information:

☎ = tap method

i☎ = iTAP mode

7 Battery Level Indicator Vertical bars show the battery charge level. Recharge the battery when you see **Low Battery** and hear the low battery alert.

8 Ring Style Indicator Shows the ring style setting:

☎ = loud ring

☎ = soft ring

☎ = vibrate

☎ = vibrate and ring

☎ = silent



9 Message Waiting Indicator Appears when you receive a text message. Other indicators can include:

☎ = voicemail message

☎ = voicemail and text message

#t = limited character count (text entry screen)

Using the 4-Way Navigation Key

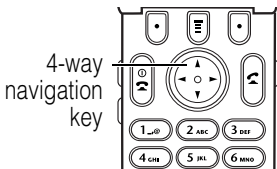

Use the 4-way navigation key like a joystick to navigate the menu system, change feature settings, and play games. From the idle display, press  to select one of the four menu feature icons in the idle display.

Tip: Down and up are your primary movements within menus. Move left and right to change feature settings, navigate the datebook, and edit text.







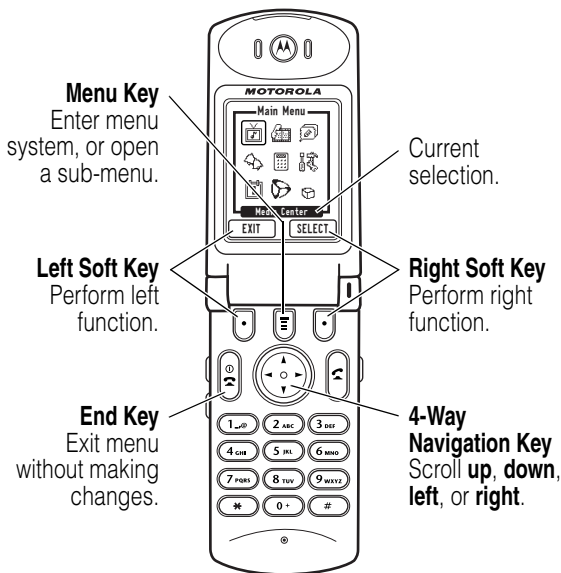







Using Menus

From the idle display, press  to go to the main menu.



Press  to highlight a menu feature icon in the main menu. Select **More** () to see additional menu features. The following icons represent features that may appear in

the main menu, depending on your service provider and service subscription options.



Menu Icon	Feature	Menu Icon	Feature
	Media Center		Phonebook
	Voice Notes		Ring Styles
	Calculator		Settings
	Datebook		Web Browser
	More		Messages
	Recent Calls		Shortcuts

Tip: You can set your phone to display the main menu as a text-based list rather than graphic icons. See page 63.

Selecting a Menu Feature

This guide shows you how to select a menu feature as follows, starting from the idle display:

Find the Feature  > **More** > **Phonebook**

This example shows that from the idle display, you must press , scroll to and select **More** () from the main menu, then scroll to and select **Phonebook**. Use  to scroll, and the left/right soft keys to select the functions listed in the bottom left and right corners of the display.



Selecting a Feature Option

Some features require you to select an item from a list:

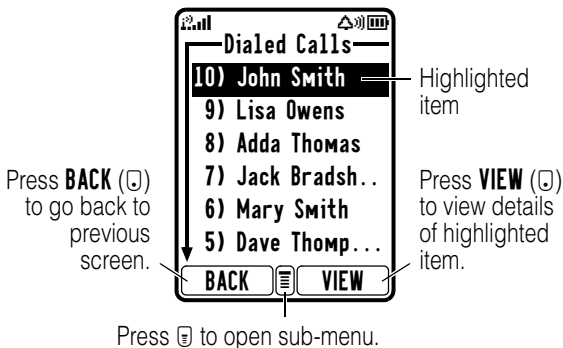



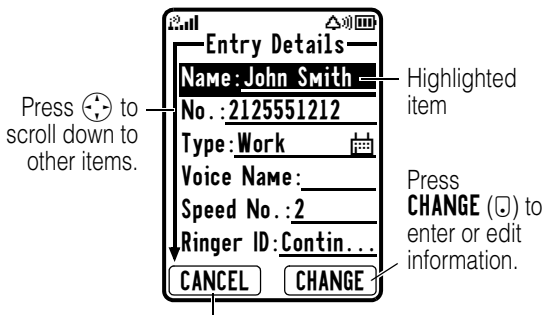

- Press [up/down] to scroll up or down to highlight the item you want.
- In a numbered list, press a number key to highlight the item.
- In an alphabetized list, press a key multiple times to cycle through the letters on the key and highlight the closest matching list item.

Entering Feature Information

Some features require you to enter information:



Press **CANCEL** () to exit without making changes. **DONE** () appears when you enter or edit information.

- Enter numbers or text with the keypad.
- When an item has a list of possible values, press  to the left or right to scroll through and select a value.
- When an item has a list of possible numeric values, press a number key to set the value.
- If you enter or edit information and do not want to save your changes, press  to exit without saving.



The message center lets you compose and send text messages. A *flashing cursor* shows where text will appear:

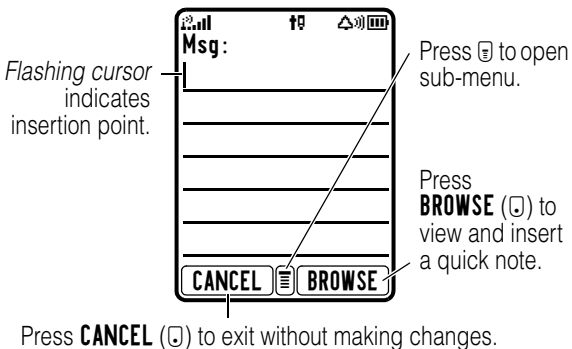

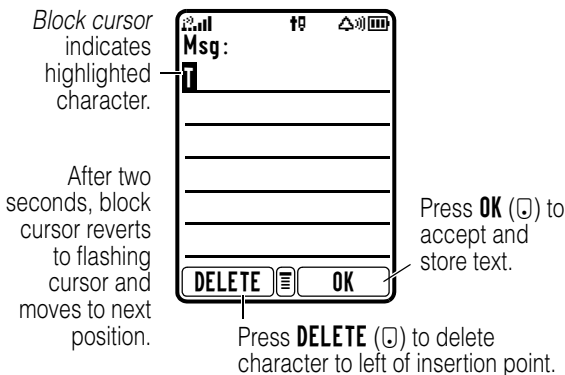

When you enter text using the standard tap method (see page 31), the flashing cursor changes to a *block cursor*, and the soft key functions change:



Entering Text

Multiple text entry methods make it easy for you to enter names, numbers, and messages on your phone.

Choosing a Text Mode

Most text entry screens let you enter letters, numbers, and/or symbols as required. Press  (or  > **Entry Method**) from a text entry screen to select a text mode:

iTAP Let the phone predict each word as you enter it. See page 34.

Tap Method Enter letters, numbers, and symbols by pressing a key one or more times. See following section.

Numeric Enter numbers only.

Symbol Enter symbols only. See page 38.

Browse Browse your phonebook or recent call lists to select a name or number.

Note: The text mode you select remains active until you change it by selecting another mode.

Using Tap Method

This is the standard mode for entering text on your phone.





Press  > **Entry Method** from any text entry screen and select the **Tap Method** menu option.

	Press	To
1	A number key one or more times	select a letter, number, or symbol shown in the “Character Chart” on page 34
2	Number keys	enter the remaining characters
3	OK ()	store the text when you are finished

General Text Entry Rules

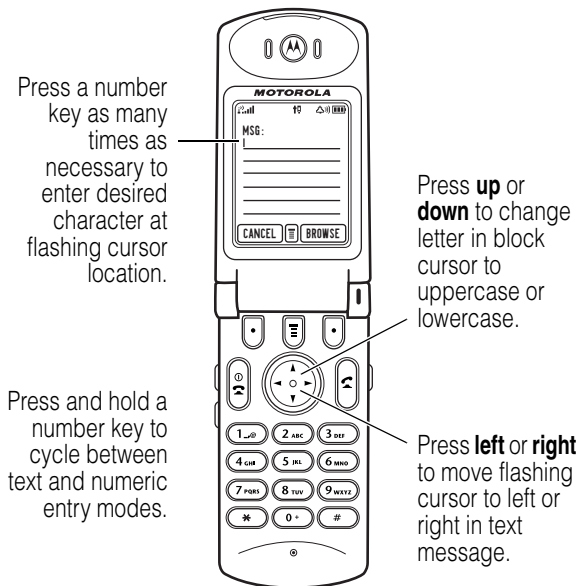
Press a number key repeatedly to cycle through its characters. See the “Character Chart” on page 34.



- If you do not press a key for two seconds, the character in the block cursor is accepted, and the cursor moves to the next position.
- The first character of every sentence is capitalized. (Press  down to force the character to lowercase while it is highlighted by the block cursor).



Character Chart

Use this chart as a guide for entering characters with the tap method.

1...☎	space . 1 ? ! , @ _ & ~ : ; " - () ' ÿ ÿ % £ \$ ¥ ¤ €
2 ABC	a b c 2 ä å á à â ã α β ç
3 DEF	d e f 3 δ ë é è ê ε φ
4 GHI	g h i 4 ï í î γ η ι
5 JKL	j k l 5 κ λ
6 MNO	m n o 6 ñ ö ø ó ò ô õ μ υ ω
7 PQRS	p q r s 7 π β σ
8 TUV	t u v 8 θ ü ú ù û τ
9 WXYZ	w x y z 9 ξ ψ
0+>	+ - 0 x * / \ [] = > < # §

Note: This chart may not reflect the exact character set available on your phone.

Using iTAP™ Software Predictive Text Entry Method

iTAP™ software is a predictive text entry method that lets you enter a word using a single keypress per letter.

Press  > **Entry Method** from any text entry screen and select the **iTAP** menu option.

Note: You can switch languages within a message in iTAP text mode. Press  > **Entry Method** to select the language you want to use.

Entering Words

Action

- 1 Press a number key one time to enter the first letter of the word

The letters associated with the key are shown at the bottom of the display.



- 2 Press number keys (one per letter) to enter the rest of the word

Alternative words and letter combinations are shown at the bottom of the display. The word choices are updated with each keypress.

- 3 Press  to highlight the word you want

- 4 Press **SELECT** () to enter the word at the flashing cursor location

A space is automatically inserted after the word.

For example, to spell the word “art,” press   . The display shows:

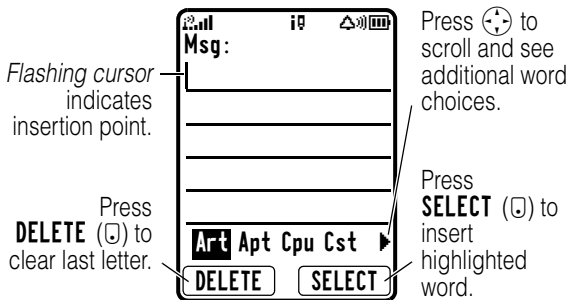

Entering Novel Words

You may enter a word that the iTAP software does not recognize. If the word you want is not displayed:

Action

- 1 Press **DELETE** (⏏) one or more times to delete letters until you see a letter combination that matches the start of the word
- 2 Press ⬅️ or ➡️ left or right to highlight the letter or letter combination
- 3 Press **SELECT** (⏏), then press ⬅️ to the left to shift the text entry cursor to the left and “lock” the selected word portion
- 4 Continue to enter letters and highlight letter combinations to spell the word

Entering Punctuation

Press	To
0+ or 1..e	enter punctuation or other characters as shown in the “Character Chart” on page 34

Using Capitalization

The first word of a sentence is automatically capitalized, with following words in lowercase.



Press	To
 up or down	change the words to initial character capitalized, all uppercase characters, or all lowercase characters

Entering Numbers

Action
1 Enter the first digit and then highlight it to put the iTAP software in number entry mode
2 Press number keys to add digits to the number
3 Press SELECT () to enter the number at the flashing cursor location

Deleting Letters and Words

Place the cursor to the right of the text you want to delete, and then do the following:



Action
Press DELETE () to delete one letter at a time
Hold DELETE () to delete the entire message



Using Symbol Mode









Your phone provides an alternate way to enter symbol characters in a message. Press  > **Entry Method** from any text entry screen and select the **Symbol** menu option.

Action

- 1 Press a number key one time to display its symbol options at the bottom of the display
See the “Symbol Chart” on page 38.
- 2 Press , or press the number key multiple times, to highlight the symbol you want
- 3 Press **SELECT** () to enter the symbol at the flashing cursor location

Symbol Chart

Use this chart as a guide for entering characters in symbol mode.

	space . ? ! , @ _ & ~ : ; " - () ' ¿ ¡ % £ \$ ¥ ¤ €
	@ _ \
	/ : ;
	" & '
	() [] { }
	¿ ¡ ~
	< > =
	\$ £ ¥ ¤ €

9WXYZ	# % *
0+	+ - x * / = > < # §

Using the Status Light

The status light shows when you have an incoming call or message, or when your phone is *roaming* (using a non-home system).

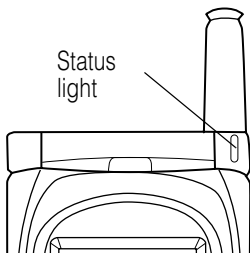

Indication	Status
alternating red/green	incoming call
flashing green	in service, home system
flashing yellow	roaming, non-home system
flashing red	no service

You can turn off the status light to extend battery life and increase your phone's *standby time*, the length of time that your phone's battery retains power when the phone is turned on but is not in use.

To turn the status light on or off:

Find the Feature

- ☰ > Settings
- > Initial Setup
- > Status Light



Using the External Display

When the flip is closed, the external display shows the time, date, and phone status information. It also displays messages to notify you of incoming calls and other events. See pages 22–24 for descriptions of the status indicators that may appear in the external display.

Locking and Unlocking Your Phone



You can lock your phone manually or set the phone to lock automatically whenever you turn it off.

To use a locked phone, you must enter the unlock code. A locked phone still rings or vibrates for incoming calls or messages, **but you must unlock it to answer.**

You can make emergency calls on your phone even when it is locked. For more information, see page 51.

Locking Your Phone Manually

Find the Feature

 > Settings > Security
> Phone Lock
> Lock Now

	Press	To
1	keypad keys	enter your unlock code
2	OK ()	lock the phone

Unlocking Your Phone

Tip: Your phone's unlock code is originally set to 1234 at the factory. Many service providers reset the unlock code to the last four digits of your phone number.

At the **Enter UnLock Code** prompt:

	Press	To
1	keypad keys	enter your unlock code
2	OK (⏏)	unlock your phone

Setting Your Phone to Lock Automatically

You can set your phone to lock every time you turn it off.

Find the Feature

☰ > Settings > Security
> Phone Lock
> Automatic Lock > On

	Press	To
1	keypad keys	enter your unlock code
2	OK (⏏)	activate automatic lock

Changing a Code or Password

Your phone's four-digit unlock code is originally set to 1234, and the six-digit security code is originally set to 000000 at the factory. Your service provider may reset these numbers before you receive your phone.

If your service provider has *not* reset these numbers, we recommend that you change them to prevent other users



from accessing your personal information. The unlock code must contain four digits, and the security code must contain six digits.

To change a code or password:



Find the Feature

 > Settings > Security
> New Passwords

If You Forget a Code or Password

If you forget your security code, contact your service provider.

If you forget your unlock code, try entering 1234 or the last four digits of your phone number. If that does not work, do the following at the **Enter Unlock Code** prompt:

Press	To
1 	go to the unlock code bypass screen
2 keypad keys	enter your security code
3 OK ()	submit your security code

Setting Up Your Phone

Storing Your Name and Phone Number



To store or edit user name and phone number information on your phone:

Find the Feature

- > Settings
- > Phone Status
- > My Tel. Numbers

Setting the Time and Date

You must set the time and date to use the datebook.

Find the Feature

- > Settings
- > Initial Setup
- > Time and Date

Setting a Ring Style

Your phone rings or vibrates to notify you of an incoming call or other event. This ring or vibration is called an *alert*.

You can select one of five different ring styles:

= loud ring

= soft ring

= vibrate

= vibrate and ring



= silent



The ring style indicator in the display shows the current ring style (see page 22).

To set a ring style:

Find the Feature  > **Ring Styles > Style**

Press	To
1 	scroll to the ring style
2 SELECT ()	select the ring style

Each ring style contains settings for specific event alerts, ringer ID, and ringer and keypad volume. To change these settings, press  > **Ring Styles > Style Detail**.

Setting Answer Options

You can use different methods to answer an incoming call.

Find the Feature  > **Settings**
 > **In-Call Setup**
 > **Answer Options**

The **Answer Options** menu includes:

Multi-Key answer by pressing any key
Open to Answer answer by opening the flip





Setting a Wallpaper Image

You can set a picture or animation as a wallpaper (background) image in your phone's idle display.

Note: When you set an animation as a wallpaper image, only the first frame of the animation is displayed.

Find the Feature

☰ > **Settings**
> **Personalize**
> **Wallpaper**

Press	To
1 	scroll to Picture
2 CHANGE (☐)	open the picture viewer
3  up or down	scroll to a picture/animation Scroll to (None) to turn off the wallpaper image.
4 SELECT (☐)	select the image
5 	scroll to Layout
6 CHANGE (☐)	adjust the image layout
7 	scroll to Center or Tile Center places the image in the center of the display and, if necessary, shrinks the image to fill the display. Tile fills the display with adjacent copies of the image
8 SELECT (☐)	confirm the layout setting
9 DONE (☐)	save wallpaper settings



Setting a Screen Saver Image

You can set a picture or animation as a screen saver image. The image is displayed when the phone flip is open and no keypresses are detected for a period of time.

The screen saver image is shrunk to fill the display, if necessary. An animation repeats for one minute, then the first frame of the animation is displayed.

Tip: Turn off the screen saver to extend battery life.



Find the Feature

- > Settings
- > Personalize
- > Screen Saver

	Press	To
1		scroll to Picture
2	CHANGE (open the picture viewer
3	up or down	scroll to a picture/animation Scroll to (None) to turn off the screen saver image.
4	SELECT (select the image
5		scroll to Delay
6	CHANGE (set the delay interval
7		scroll to the inactivity interval that triggers the screen saver
8	SELECT (confirm the delay setting
9	DONE (save screen saver settings



Zooming In and Out

Press and release , then press and hold  to zoom in and out on display text. Zoom in to increase text size, zoom out to display more information.

You can also zoom in and out from the menu:

Find the Feature

 > Settings
> Initial Setup > Zoom

Setting Display Contrast

Find the Feature

 > Settings
> Initial Setup
> Contrast

Setting Display Color

You can select the color palette that your phone uses to display indicators, highlights, and soft key labels.

Find the Feature

 > Settings
> Personalize
> Color Style

Adjusting the Backlight

You can set the amount of time that the display and keypad backlights remain on, or turn off backlights to extend battery life.

Find the Feature

 > Settings
> Initial Setup
> Backlight



Hiding or Showing Location Information



Your phone can use the *automatic location information* (ALI) feature to tell the network where you are physically located.

When ALI is set to **Location On**, your phone displays the (ALI on) indicator. Services may use your known location to provide useful information (for example, driving directions, or the location of the nearest bank). Your phone prompts you when the network or a service asks for your location. You can refuse at this point.

When ALI is set to **911 Only**, your phone displays the (ALI off) indicator, and the phone does not send location information unless you call the emergency phone number (such as 911).

Find the Feature

> **Settings** > **Location**

Press	To
1	scroll to Location On or 911 Only
2 SELECT ()	select the setting

To view or change the location transmission status of your phone during a call, press > **Location**.

Calling Features

For basic instructions on how to make and answer calls, see page 19.

Changing the Active Line



Change the active phone line to make and receive calls from your other phone number.

Find the Feature

- > Settings
- > Phone Status
- > Active Line

The active line indicator in the display shows the current active phone line. See page 22.

Redialing a Number

If you hear an ordinary busy signal:

Press	To
1	hang up
2	redial the busy number

Using Automatic Redial

If the network is busy, you hear a fast busy signal, and your phone displays **Call Failed**.





With automatic redial, your phone automatically redials the number for four minutes. When the call goes through, your phone rings or vibrates one time, displays **Redial Successful**, and then connects the call.

You must turn on automatic redial to use the feature. To turn automatic redial on or off:

Find the Feature

- > Settings
- > Initial Setup
- > Auto Redial

When automatic redial is turned off, you can manually activate the feature to redial a phone number. When you hear a fast busy signal and see **Call Failed**:

Press	To
 or RETRY ()	activate automatic redial

Using Caller ID



Calling line identification (caller ID) displays the phone number for incoming calls in your phone's external and internal displays.

The phone displays the caller's name when the name is stored in your phonebook, or **Incoming Call** when caller ID information is not available.

Canceling an Incoming Call

While the phone is ringing or vibrating:

Press



or **IGNORE** (⏏)

To

cancel the incoming call



Depending on your phone settings and/or service subscription, the call may be forwarded to another number, or the caller may hear a busy signal.

Turning Off a Call Alert

You can turn off your phone's incoming call alert before answering the call.

Press

either volume key

To

turn off the alert

Calling an Emergency Number

Your service provider programs one or more emergency phone numbers, such as 911, that you can call under any circumstances, even when your phone is locked.

Note: Emergency numbers vary by country. Your phone's preprogrammed emergency number(s) may not work in all locations, and sometimes an emergency call cannot be



placed due to network, environmental, or interference issues.



	Press	To
1	keypad keys	dial the emergency number
2		call the emergency number

Viewing Recent Calls





Your phone keeps a list of the calls you recently received and dialed, even if the calls did not connect. The lists are sorted from newest to oldest entries. The oldest entries are deleted as new ones are added.

Shortcut: Press  to go directly to the dialed calls list from the idle display.

Find the Feature  > **More** > **Recent Calls**

	Press	To
1		scroll to Received Calls or Dialed Calls
2	SELECT ()	select the list
3		scroll to an entry
		Note: ✓ means the call connected.



Press	To
4 	call the entry's number Tip: Press and hold  for two seconds to send the number as DTMF tones during a call.
or	
VIEW 	view entry details
or	
	open the Last Calls Menu to perform other procedures

The **Last Calls Menu** can include the following options:



Option	Description
Store	Create a phonebook entry with the number in the No. field.
Delete	Delete the entry.
Delete All	Delete all entries in the list.
Send Message	Open a new text message with the number in the To field.
Add Digits	Add digits after the number.
Attach Number	Attach a number from the phonebook or recent call lists, after the highlighted number.
Send Tones	Send the number to the network as DTMF tones. Note: This option appears only during a call.



Returning an Unanswered Call

Your phone keeps a record of your unanswered calls, and displays:

- the  (missed call) indicator
- **X Missed Calls**, where **X** is the number of missed calls

	Press	To
1	VIEW ()	see the received calls list
2		select a call to return
3		make the call



Using the Notepad

Your phone stores the most recent string of digits entered on the keypad in a temporary memory location called the *notepad*. This can be a phone number that you called, or a number that you entered but did not call. To retrieve the number stored in the notepad:

Find the Feature

 > **More** > **Recent Calls**
> **Notepad**



Press	To
	call the number
or	
	open the Dialing Menu to attach a number or insert a special character
or	
STORE ()	create a phonebook entry with the number in the No. field

Attaching a Number



While dialing (with digits visible in the display):

Press	To
 > Attach Number	attach a number from the phonebook or recent call lists



Calling With Speed Dial

Each entry you store in your phonebook is assigned a unique *speed dial* number. To speed dial a phonebook entry:

Press	To
1 keypad keys	enter the speed dial number for the entry you want to call
2 	submit the number
	<p>Note: Some networks let you skip this step for speed dial numbers 1 through 99.</p>
3 	call the entry



Calling With One-Touch Dial

To call phonebook entries 1 through 9, just press and hold the one-digit speed dial number for one second.

We recommend that you reserve phonebook entry 1 (speed dial number 1) for storing and dialing your voicemail phone number. Usually, your service provider has already done this for you. If necessary, see your reference guide for information on how to store your voicemail number as a phonebook entry.

Using Voicemail



Voicemail messages that you receive are stored on the network. To listen to your messages, you must call your voicemail phone number.

Note: Your service provider may include additional information about using this feature.

Listening to Voicemail Messages

Find the Feature

 > More > Messages
> VoiceMail

The phone calls your voicemail phone number. If no voicemail number is stored, your phone prompts you to store one.

Shortcut: Your service provider may also store your voicemail phone number as phonebook entry number 1. If so, you can press and hold  to listen to your voicemail message(s).

Receiving a Voicemail Message

When you receive a voicemail message, your phone displays the  (voice message waiting) indicator and a **New VoiceMail** notification.

Press

To

CALL 

listen to the message

The phone calls your voicemail phone number. If no voicemail number is stored, your phone prompts you to store one.



Storing Your Voicemail Phone Number

If necessary, use the following procedure to store your voicemail phone number on your phone. Usually, your service provider has already done this for you.



Find the Feature

 > **More** > **Messages**
 > **VoiceMail Setup**

Press	To
1 keypad keys	enter your voicemail number
2 OK ()	store the number

Your service provider additionally may store your voicemail phone number as phonebook entry number 1, so you can use one-touch dial to listen to your voicemail messages. If necessary, see your reference guide for information on how to store your voicemail number as a phonebook entry.



Muting the Phone

To mute your phone during a call, press **MUTE** () (if available) or  > **Mute**.

Using Call Waiting



When you are on a call, an alert tone sounds to indicate that you have received a second call.

Press	To
1 	answer the new call
2 	switch back to the first call

Phone Features

Main Menu

This is the standard main menu layout. **Menu organization and feature names may vary on your phone.** If you do not find a feature in the main menu, select **More** (☰) to see additional menu features. Not all features may be available for all users.

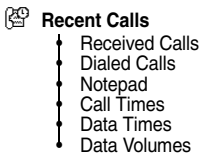
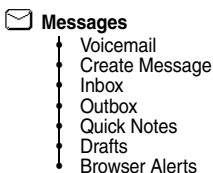
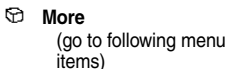
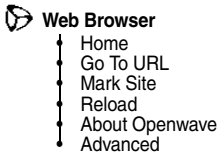
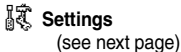

Settings Menu

Personalize

- Main Menu
- Home Keys
- Color Style
- Greeting
- Banner
- Banner Graphic
- Wallpaper
- Screen Saver

Browser Setup

Connection

- Incoming Call

In-Call Setup

- In-Call Timer
- Answer Options

Phone Status

- My Tel. Numbers
- Active Line
- Battery Meter
- Other Information

Security

- Phone Lock
- Lock Application
- Restrict Calls
- New Passwords
- Data Connection



Initial Setup

- Time and Date
- Auto Redial
- Backlight
- Status Light
- Zoom
- TTY Setup
- Scroll
- Language
- Contrast
- DTMF
- Master Reset
- Master Clear

- Location
- Network
- Car Settings
- Headset

Shortcuts



Change display zoom:

Press , then
press and hold 

Change ringer alert:

Open flip, press down
volume key to decrease
volume, then switch to
silent alert. Press up
volume key to reset ring
alert and increase volume.

Display my phone number:

Press   (in idle)

Go to dialed calls list:

Press  (in idle)

Exit menu system:





Press 

Feature Quick Reference

You can do more with your phone than make and receive phone calls! For example, you can store frequently called numbers in the phonebook for easy dialing, organize your meetings and other events in the datebook, browse the Web, send messages, and more.



Use this chapter to locate features on your phone that are not described in this guide. For more detailed information, see the *More Here* guide.

Calling Features

Feature	Description
Three-Way Call	During a call: Dial third party's number, press  to call, press  again to connect
Restrict Calls	Restrict outgoing or incoming calls:  > Settings > Security > Restrict Calls
TTY Calls	Set up your phone for use with an optional TTY device:  > Settings > Initial Setup > TTY Setup



Messages

Feature	Description	
Send Message	Send a text message: ☰ > More > Messages > Create Message	
Receive Message	Read a new text message that you have received: Press READ (☐)	

Phonebook

Feature	Description	
Create Entry	Create a new phonebook entry: ☰ > More > Phonebook ☰ > New > Phone Number or Email Address	
Dial Number	Call a number stored in the phonebook: ☰ > More > Phonebook > <i>entry to call</i>	
Voice Dial Number	Voice dial a number stored in the phonebook: Press and release the voice key, and say the entry's name (in two seconds)	



Personalizing Features

Feature	Description
Ring Alert	Change the ring alert for an event: ☰ > Ring Styles > <i>Style Detail</i> > <i>event name</i>
Ring Volume	Set ringer volume: ☰ > Ring Styles > <i>Style Detail</i> > Ring Volume
Keypad Volume	Set keypad keypress volume: ☰ > Ring Styles > <i>Style Detail</i> > Key Volume
Menu View	Display the main menu as graphic icons or as a text-based list: ☰ > Settings > Personalize > Main Menu > View
Soft Keys & Menu Icons	Change soft key labels and menu feature icons in the idle display: ☰ > Settings > Personalize > Home Keys
Shortcuts	Create a shortcut to a menu item: Highlight the menu item, then press and hold ☰ Select a shortcut: ☰ > More > Shortcuts > <i>shortcut name</i>



Menu Features

Feature	Description
Language	Set menu language: ☰ > Settings > Initial Setup > Language
Master Reset	Reset all options <i>except</i> unlock code, security code, lifetime timer: ☰ > Settings > Initial Setup > Master Reset
Master Clear	Reset all options <i>except</i> unlock code, security code, lifetime timer, clear all user settings and entries: ☰ > Settings > Initial Setup > Master Clear

Dialing Features









Feature	Description
DTMF Tones	Activate DTMF tones: ☰ > Settings > Initial Setup > DTMF Send DTMF tones during a call: Press number keys Send stored numbers as DTMF tones during a call: Highlight a number in the phonebook or recent call lists, then press ☰ > Send Tones



Call Monitoring

Network connection time is the elapsed time from the moment you connect to your service provider's network to the moment you end the call by pressing . This time includes busy signals and ringing.

The amount of network connection time you track on your resettable timer may not equal the amount of time for which you are billed by your service provider. For billing information, please contact your service provider directly.





Feature	Description	
Call Times	View call timers:  > More > Recent Calls > Call Times	
In-Call Timer	Display time or cost information during a call:  > Settings > In-Call Setup > In-Call Timer	
Data Times	View data call timers:  > More > Recent Calls > Data Times	
Data Volumes	View data volume meters:  > More > Recent Calls > Data Volumes	

Handsfree Features

Note: The use of wireless devices and their accessories may be prohibited or restricted in certain







areas. Always obey the laws and regulations on the use of these products.



Feature	Description	
Speaker- phone	Activate a connected external speakerphone during a call: Press SPEAKER (☐) (if available) or ☒ > Spkrphone On	
Auto Answer (car kit or headset)	Automatically answer calls when connected to a car kit or headset: ☒ > Settings > Car Settings or Headset > Auto Answer	
Auto Hands- Free (car kit)	Automatically route calls to a car kit when connected: ☒ > Settings > Car Settings > Auto Handsfree	
Power-Off Delay (car kit)	Set the phone to stay on for a period of time after the ignition is switched off: ☒ > Settings > Car Settings > Power-Off Delay	
Charger Time (car kit)	Charge the phone for a period of time after the ignition is switched off: ☒ > Settings > Car Settings > Charger Time	



Data and Fax Calls

Feature	Description
Send Data or Fax	Connect your phone to the device, then place the call through the device application 
Receive Data or Fax	Connect your phone to the device, then:  > Settings > Connection > Incoming Call > Next Call > Data In Only or Fax In Only Reset normal voice operation:  > Settings > Connection > Incoming Call > Next Call > Normal 

Network Features

Feature	Description
Network Settings	View network information and adjust network settings:  > Settings > Network 



Personal Organizer Features







Feature	Description
Add Datebook Event	Add an event to the datebook: ☰ > Datebook > <i>day</i> ☰ > New
View Datebook Event	View or edit event details: ☰ > Datebook > <i>day</i> > <i>event name</i>
Event Reminder	View event reminder: VIEW (☐) Dismiss event reminder: EXIT (☐)
Record Voice Note	Record a voice note: Press and hold voice key, speak voice note, release voice key Note: Recording phone calls is subject to varying state and federal laws regarding privacy and recording of conversations.
Play Voice Note	Play back a recorded voice note: ☰ > Voice Notes > <i>voice note</i>
Calculator	Calculate numbers: ☰ > Calculator
Currency Converter	Convert currency: ☰ > Calculator ☰ > Exchange Rate Enter exchange rate, press OK (☐), enter amount, select \$ function



Security

Feature	Description
Lock Application	Lock phone applications:  > Settings > Security > Lock Application

News and Entertainment

Feature	Description
Launch Micro-Browser	Start a micro-browser session:  > Web Browser > Home 
Picture Viewer	Manage pictures and animations:  > Media Center > Picture Viewer 
My Tones	Compose and manage your own ring tones:  > Media Center > My Tones
Radio	Use the optional Motorola Original™ FM Stereo Radio Headset accessory:  > Media Center > Radio 



Specific Absorption Rate Data

The model wireless phone meets the government's requirements for exposure to radio waves.

Your wireless phone is a radio transmitter and receiver. It is designed and manufactured not to exceed limits for exposure to radio frequency (RF) energy set by the Federal Communications Commission (FCC) of the U.S. Government and by the Canadian regulatory authorities. These limits are part of comprehensive guidelines and establish permitted levels of RF energy for the general population. The guidelines are based on standards that were developed by independent scientific organizations through periodic and thorough evaluation of scientific studies. The standards include a substantial safety margin designed to assure the safety of all persons, regardless of age or health.

The exposure standard for wireless mobile phones employs a unit of measurement known as the Specific Absorption Rate, or SAR. The SAR limit set by the FCC and by the Canadian regulatory authorities is 1.6 W/kg.¹ Tests for SAR are conducted using standard operating positions accepted by the FCC and by Industry Canada with the phone transmitting at its highest certified power level in all tested frequency bands. Although the SAR is determined at the highest certified power level, the actual SAR level of the phone while operating can be well below the maximum value. This is because the phone is designed to operate at multiple power levels so as to use only the power required to reach the network. In general, the closer you are to a wireless base station, the lower the power output.

Before a phone model is available for sale to the public in the U.S. and Canada, it must be tested and certified to the FCC and Industry Canada that it does not exceed the limit established by each government for safe exposure. The tests are performed in positions and locations (e.g., at the ear and worn on the body) reported to the FCC and available for review by Industry Canada. The highest SAR value for this model phone when tested for use at the ear is 1.56 W/kg, and when worn on the body, as

described in this user guide, is 1.30 W/kg. (Body-worn measurements differ among phone models, depending upon available accessories and regulatory requirements).²

While there may be differences between the SAR levels of various phones and at various positions, they all meet the governmental requirements for safe exposure. Please note that improvements to this product model could cause differences in the SAR value for later products; in all cases, products are designed to be within the guidelines.

Additional information on Specific Absorption Rates (SAR) can be found on the Cellular Telecommunications & Internet Association (CTIA) Web site:

<http://phonefacts.net>

or the Canadian Wireless Telecommunications Association (CWTA) Web site:

<http://www.cwta.ca>

1. In the United States and Canada, the SAR limit for mobile phones used by the public is 1.6 watts/kg (W/kg) averaged over one gram of tissue. The standard incorporates a substantial margin of safety to give additional protection for the public and to account for any variations in measurements.
2. The SAR information includes the Motorola testing protocol, assessment procedure, and measurement uncertainty range for this product.

Consumer Information on Wireless Phones from the FDA



The U.S. Food and Drug Administration (FDA) provides consumer information on wireless phones at:

<http://www.fda.gov/cellphones/qa.html>

Following are safety-related questions and answers discussed at this web site.

Do wireless phones pose a health hazard?

The available scientific evidence does not show that any health problems are associated with using wireless phones. There is no proof, however, that wireless phones are absolutely safe. Wireless phones emit low levels of radio frequency energy (RF) in the microwave range while being used. They also emit very low levels of RF when in the stand-by mode. Whereas high levels of RF can produce health effects (by heating tissue), exposure to low level RF that does not produce heating effects causes no known adverse health effects. Many studies of low level RF exposures have not found any biological effects. Some studies have suggested that some biological effects may occur, but such findings have not been confirmed by additional research. In some cases, other researchers have had difficulty in reproducing those studies, or in determining the reasons for inconsistent results.

What is FDA's role concerning the safety of wireless phones?

Under the law, FDA does not review the safety of radiation-emitting consumer products such as wireless phones before they can be sold, as it does with new drugs or medical devices. However, the agency has authority to take action if wireless phones are shown to emit radio frequency energy (RF) at a level that is hazardous to the user. In such a

case, FDA could require the manufacturers of wireless phones to notify users of the health hazard and to repair, replace or recall the phones so that the hazard no longer exists.

Although the existing scientific data do not justify FDA regulatory actions, FDA has urged the wireless phone industry to take a number of steps, including the following:

- Support needed research into possible biological effects of RF of the type emitted by wireless phones;
- Design wireless phones in a way that minimizes any RF exposure to the user that is not necessary for device function; and
- Cooperate in providing users of wireless phones with the best possible information on possible effects of wireless phone use on human health.

FDA belongs to an interagency working group of the federal agencies that have responsibility for different aspects of RF safety to ensure coordinated efforts at the federal level. The following agencies belong to this working group:

- National Institute for Occupational Safety and Health
- Environmental Protection Agency
- Federal Communications Commission
- Occupational Safety and Health Administration
- National Telecommunications and Information Administration

The National Institutes of Health participates in some interagency working group activities, as well.

FDA shares regulatory responsibilities for wireless phones with the Federal Communications Commission (FCC). All phones that are sold in the United States must comply with FCC safety guidelines that limit RF exposure. FCC relies on FDA and other health agencies for safety questions about wireless phones.

FCC also regulates the base stations that the wireless phone networks rely upon. While these base stations operate at higher power than do the wireless phones themselves, the RF exposures that people get from these base stations are typically thousands of times lower than those they can get from wireless phones. Base stations are thus not the primary subject of the safety questions discussed in this document.

What is FDA doing to find out more about the possible health effects of wireless phone RF?

FDA is working with the U.S. National Toxicology Program and with groups of investigators around the world to ensure that high priority animal studies are conducted to address important questions about the effects of exposure to radio frequency energy (RF).

FDA has been a leading participant in the World Health Organization International Electromagnetic Fields (EMF) Project since its inception in 1996. An influential result of this work has been the development of a detailed agenda of research needs that has driven the establishment of new research programs around the world. The Project has also helped develop a series of public information documents on EMF issues.

FDA and the Cellular Telecommunications & Internet Association (CTIA) have a formal Cooperative Research and Development Agreement (CRADA) to do research on wireless phone safety. FDA provides the scientific oversight, obtaining input from experts in government, industry, and academic organizations. CTIA-funded research is conducted through contracts to independent investigators. The initial research will include both laboratory studies and studies of wireless phone users. The CRADA will also include a broad assessment of additional research needs in the context of the latest research developments around the world.

What steps can I take to reduce my exposure to radio frequency energy from my wireless phone?

If there is a risk from these products--and at this point we do not know that there is--it is probably very small. But if you are concerned about avoiding even potential risks, you can take a few simple steps to minimize your exposure to radio frequency energy (RF). Since time is a key factor in how much exposure a person receives, reducing the amount of time spent using a wireless phone will reduce RF exposure.

If you must conduct extended conversations by wireless phone every day, you could place more distance between your body and the source of the RF, since the exposure level drops off dramatically with distance. For example, you could use a headset and carry the wireless phone away from your body or use a wireless phone connected to a remote antenna.

Again, the scientific data do not demonstrate that wireless phones are harmful. But if you are concerned about the RF exposure from these products, you can use measures like those described above to reduce your RF exposure from wireless phone use.

What about children using wireless phones?

The scientific evidence does not show a danger to users of wireless phones, including children and teenagers. If you want to take steps to lower exposure to radio frequency energy (RF), the measures described above would apply to children and teenagers using wireless phones. Reducing the time of wireless phone use and increasing the distance between the user and the RF source will reduce RF exposure.

Some groups sponsored by other national governments have advised that children be discouraged from using wireless phones at all. For example, the government in the United Kingdom distributed leaflets containing such a recommendation in December 2000. They noted that no evidence exists that using a wireless phone causes brain tumors or other ill effects. Their recommendation to limit wireless phone use by

children was strictly precautionary; it was not based on scientific evidence that any health hazard exists.

Do hands-free kits for wireless phones reduce risks from exposure to RF emissions?

Since there are no known risks from exposure to RF emissions from wireless phones, there is no reason to believe that hands-free kits reduce risks. Hands-free kits can be used with wireless phones for convenience and comfort. These systems reduce the absorption of RF energy in the head because the phone, which is the source of the RF emissions, will not be placed against the head. On the other hand, if the phone is mounted against the waist or other part of the body during use, then that part of the body will absorb more RF energy. Wireless phones marketed in the U.S. are required to meet safety requirements regardless of whether they are used against the head or against the body. Either configuration should result in compliance with the safety limit.

Do wireless phone accessories that claim to shield the head from RF radiation work?

Since there are no known risks from exposure to RF emissions from wireless phones, there is no reason to believe that accessories that claim to shield the head from those emissions reduce risks. Some products that claim to shield the user from RF absorption use special phone cases, while others involve nothing more than a metallic accessory attached to the phone. Studies have shown that these products generally do not work as advertised. Unlike “hand-free” kits, these so-called “shields” may interfere with proper operation of the phone. The phone may be forced to boost its power to compensate, leading to an increase in RF absorption. In February 2002, the Federal Trade Commission (FTC) *charged two companies* that sold devices that claimed to protect wireless phone users from radiation with making false and unsubstantiated claims. According to FTC, these defendants lacked a reasonable basis to substantiate their claim.

Motorola Limited Warranty for the United States and Canada

What Does this Warranty Cover?

Subject to the exclusions contained below, Motorola, Inc. warrants its telephones, pagers, messaging devices, and consumer and professional two-way radios (excluding commercial, government or industrial radios) that operate via Family Radio Service or General Mobile Radio Service, Motorola-branded or certified accessories sold for use with these Products (“Accessories”) and Motorola software contained on CD-ROMs or other tangible media and sold for use with these Products (“Software”) to be free from defects in materials and workmanship under normal consumer usage for the period(s) outlined below. This limited warranty is a consumer's exclusive remedy, and applies as follows to new Motorola Products, Accessories and Software purchased by consumers in the United States or Canada, which are accompanied by this written warranty:

Products and Accessories

Products Covered	Length of Coverage
Products and Accessories as defined above, unless otherwise provided for below.	One (1) year from the date of purchase by the first consumer purchaser of the product unless otherwise provided for below.
Motorola T720 Series and T730 Series wireless phones sold and purchased in Canada.	Two (2) years from the date of purchase by the first consumer purchaser of the product.
Decorative Accessories and Cases. Decorative covers, bezels, PhoneWrap™ covers and cases.	Limited lifetime warranty for the lifetime of ownership by the first consumer purchaser of the product.

Products Covered	Length of Coverage
Monaural Headsets. Ear buds and boom headsets that transmit mono sound through a wired connection.	Limited lifetime warranty for the lifetime of ownership by the first consumer purchaser of the product.
Consumer and Professional Two-Way Radio Accessories.	Ninety (90) days from the date of purchase by the first consumer purchaser of the product.
Products and Accessories that are Repaired or Replaced.	The balance of the original warranty or for ninety (90) days from the date returned to the consumer, whichever is longer.

Exclusions

Normal Wear and Tear. Periodic maintenance, repair and replacement of parts due to normal wear and tear are excluded from coverage.

Batteries. Only batteries whose fully charged capacity falls below 80% of their rated capacity and batteries that leak are covered by this limited warranty.

Abuse & Misuse. Defects or damage that result from: (a) improper operation, storage, misuse or abuse, accident or neglect, such as physical damage (cracks, scratches, etc.) to the surface of the product resulting from misuse; (b) contact with liquid, water, rain, extreme humidity or heavy perspiration, sand, dirt or the like, extreme heat, or food; (c) use of the Products or Accessories for commercial purposes or subjecting the Product or Accessory to abnormal usage or conditions; or (d) other acts which are not the fault of Motorola, are excluded from coverage.

Use of Non-Motorola Products and Accessories. Defects or damage that result from the use of Non-Motorola branded or certified Products, Accessories, Software or other peripheral equipment are excluded from coverage.

Unauthorized Service or Modification. Defects or damages resulting from service, testing, adjustment, installation, maintenance, alteration, or modification in any way by someone other than Motorola, or its authorized service centers, are excluded from coverage.

Altered Products. Products or Accessories with (a) serial numbers or date tags that have been removed, altered or obliterated; (b) broken seals or that show evidence of tampering; (c) mismatched board serial numbers; or (d) nonconforming or non-Motorola housings, or parts, are excluded from coverage.

Communication Services. Defects, damages, or the failure of Products, Accessories or Software due to any communication service or signal you may subscribe to or use with the Products Accessories or Software is excluded from coverage.

Software

Products Covered	Length of Coverage
Software. Applies only to physical defects in the media that embodies the copy of the software (e.g. CD-ROM, or floppy disk).	Ninety (90) days from the date of purchase.

Exclusions

Software Embodied in Physical Media. No warranty is made that the software will meet your requirements or will work in combination with any hardware or software applications provided by third parties, that the operation of the software products will be uninterrupted or error free, or that all defects in the software products will be corrected.

Software NOT Embodied in Physical Media. Software that is not embodied in physical media (e.g. software that is downloaded from the internet), is provided “as is” and without warranty.

Who is Covered?

This warranty extends only to the first consumer purchaser, and is not transferable.

What Will Motorola Do?

Motorola, at its option, will at no charge repair, replace or refund the purchase price of any Products, Accessories or Software that does not conform to this warranty. We may use functionally equivalent reconditioned/refurbished/pre-owned or new Products, Accessories or parts. No data, software or applications added to your Product, Accessory or Software, including but not limited to personal contacts, games and ringer tones, will be reinstalled. To avoid losing such data, software and applications please create a back up prior to requesting service.

How to Obtain Warranty Service or Other Information

USA	Phones 1-800-331-6456 Pagers 1-800-548-9954 Two-Way Radios and Messaging Devices 1-800-353-2729
Canada	All Products 1-800-461-4575
TTY	1-888-390-6456
For Accessories and Software , please call the telephone number designated above for the product with which they are used.	

You will receive instructions on how to ship the Products, Accessories or Software, at your expense, to a Motorola Authorized Repair Center. To obtain service, you must include: (a) a copy of your receipt, bill of sale or other comparable proof of purchase; (b) a written description of the problem; (c) the name of your service provider, if applicable; (d) the name and location of the installation facility (if applicable) and, most importantly; (e) your address and telephone number.

What Other Limitations Are There?

ANY IMPLIED WARRANTIES, INCLUDING WITHOUT LIMITATION THE IMPLIED WARRANTIES OF MERCHANTABILITY AND FITNESS FOR A PARTICULAR PURPOSE, SHALL BE LIMITED TO THE DURATION OF

THIS LIMITED WARRANTY, OTHERWISE THE REPAIR, REPLACEMENT, OR REFUND AS PROVIDED UNDER THIS EXPRESS LIMITED WARRANTY IS THE EXCLUSIVE REMEDY OF THE CONSUMER, AND IS PROVIDED IN LIEU OF ALL OTHER WARRANTIES, EXPRESS OR IMPLIED. IN NO EVENT SHALL MOTOROLA BE LIABLE, WHETHER IN CONTRACT OR TORT (INCLUDING NEGLIGENCE) FOR DAMAGES IN EXCESS OF THE PURCHASE PRICE OF THE PRODUCT, ACCESSORY OR SOFTWARE, OR FOR ANY INDIRECT, INCIDENTAL, SPECIAL OR CONSEQUENTIAL DAMAGES OF ANY KIND, OR LOSS OF REVENUE OR PROFITS, LOSS OF BUSINESS, LOSS OF INFORMATION OR DATA, SOFTWARE OR APPLICATIONS OR OTHER FINANCIAL LOSS ARISING OUT OF OR IN CONNECTION WITH THE ABILITY OR INABILITY TO USE THE PRODUCTS, ACCESSORIES OR SOFTWARE TO THE FULL EXTENT THESE DAMAGES MAY BE DISCLAIMED BY LAW.

Some states and jurisdictions do not allow the limitation or exclusion of incidental or consequential damages, or limitation on the length of an implied warranty, so the above limitations or exclusions may not apply to you. This warranty gives you specific legal rights, and you may also have other rights that vary from state to state or from one jurisdiction to another.

Laws in the United States and other countries preserve for Motorola certain exclusive rights for copyrighted Motorola software such as the exclusive rights to reproduce and distribute copies of the Motorola software. Motorola software may only be copied into, used in, and redistributed with, the Products associated with such Motorola software. No other use, including without limitation disassembly of such Motorola software or exercise of the exclusive rights reserved for Motorola, is permitted.

Product Registration

Online Product Registration:

<http://www.motorola.com/warranty>

Product registration is an important step toward enjoying your new Motorola phone. Registering helps us facilitate warranty service, and permits us to contact you should your phone require an update or other service. Registration is for U.S. residents only and is not required for warranty coverage.

Please retain your original dated sales receipt for your records. For warranty service of your Motorola Personal Communications Product you will need to provide a copy of your dated sales receipt to confirm warranty status.

Thank you for choosing a Motorola product.

Export Law Assurances

This product is controlled under the export regulations of the United States of America and Canada. The Governments of the United States of America and Canada may restrict the exportation or re-exportation of this product to certain destinations. For further information contact the U.S. Department of Commerce or the Canadian Department of Foreign Affairs and International Trade.

RF Energy Interference

This device complies with Part 15 of the FCC Rules. Operation is subject to the following two conditions: (1) this device may not cause harmful interference, and (2) this device must accept any interference received, including interference that may cause undesired operation.

Index

A

- accessories 12, 13, 17, 61
- accessory connector port 1
- active line indicator 22, 23
- alert
 - creating 69
 - defined 43
 - setting 63
 - turning off 19, 20, 51
- ALI indicators 22, 24, 48
- analog signal indicator 22
- animation
 - screen saver 46
 - viewing 69
 - wallpaper 44
- answering a call 20, 44
- antenna 19
- application, locking and
 - unlocking 69
- automatic location
 - information
 - indicators 24
 - sending 48
- automatic redial 49

B

- backlight 47

battery

- car kit charger time 66
- charging 14
- extending battery life 15, 39, 46, 47
- installing 13
- level indicator 15, 22, 24
- block cursor 30, 33
- browse text mode 31

C

- calculator 68
- call
 - adding digits after phone number 53
 - alert, setting 63
 - alert, turning off 19, 20, 51
 - answer options 44
 - answering 20
 - call waiting 58
 - canceling 51
 - deleting 52
 - dialed calls list 52
 - dialing 19
 - emergency number 51
 - ending 19, 20
 - making 19

- call (continued)
 - muting 58
 - received calls list 52
 - receiving 20
 - recent calls 52
 - restricting 61
 - speakerphone 66
 - storing 52
 - three-way call 61
 - timers 65
 - unanswered call 54

- Call Failed** message 49
- call waiting 58
- caller ID 50, 54
- calling line identification.
See caller ID

- car kit
 - automatic answer 66
 - automatic hands-free 66
 - charger time 66
 - power-off delay 66

- character chart 34

- clock
 - illustration 21
 - setting 43

- codes
 - changing 41
 - default 18, 41
 - forgetting 42

- color, setting 47
- contrast, setting 47
- convertible covers 17

- cursor 30, 33
- customizing the menu 63

D

- data call
 - receiving 67
 - sending 67
 - timers 65
 - volume meters 65
- date, setting 43
- datebook 68
 - menu feature icon 21, 22
- deleting a call 52
- dialed calls list 52
- dialing a number 19
- digital signal indicator 22
- display
 - backlight 47
 - color 47
 - contrast 47
 - description 21
 - idle display, defined 21
 - language 64
 - menu icons, personalizing 63
 - zooming in/out 47
- DTMF tones
 - activating 64
 - sending 53, 64

E

- earpiece volume 19

emergency number 51
end key 1, 19, 20, 26
ending a call 19, 20
Enter Unlock Code message
 41, 42
event alert 63
external display 40

F

fax call
 receiving 67
 sending 67
flashing cursor 30, 33
flip
 external display 40
 open to answer 20, 44
 replacing flip cover 17
 screen saver 46
FM Stereo Radio Headset
 69
4-way navigation key 1, 25,
 26

H

hands-free use
 automatic answer 66
 automatic call routing 66
 charger time 66
 power-off delay 66
 speakerphone, activating
 66

headset
 automatic answer 66
 FM Stereo Radio Headset
 69
headset jack 1
home keys, personalizing
 63

I

idle display 21
in use indicator 22, 23
Incoming Call message 50
incoming call, canceling 51
indicators
 active line 22, 23
 ALI 22, 24, 48
 battery level 15, 22, 24
 digital/analog signal 22
 in use 22, 23
 loud ring style 24, 43
 menu 21
 message waiting 22, 24
 missed call 54
 ring style 22
 roam 22, 23
 signal strength 22
 silent ring style 24, 43
 soft ring style 24, 43
 text entry mode 24
 vibrate and ring style 24,
 43

indicators (continued)
vibrate style 24, 43
voice message waiting
57
iTAP software 34

J

joystick 1, 26

K

key

end 1, 19, 20, 26
4-way navigation 1, 25,
26
left soft key 1, 22, 26, 63
menu 1, 26, 27
power 1, 18
right soft key 1, 22, 26,
63
send 1, 19, 20, 52
voice 1
volume control 1, 19

keypad

answering calls 44
backlight 47
volume, setting 63

L

language, setting 64

left soft key

functions 1, 22, 26
personalizing 63

location, sending to network
48

lock

application 69
phone 40

Low Battery message 24

M

making a call 19

master clear 64

master reset 64

menu

entering text 29, 31
icons, changing in idle
display 63
icons, converting to text
63
icons, described 21
language, setting 64
lists 28
navigating 26
using features 28
view, changing 63

menu indicator 21

menu key 1, 26, 27

message

menu feature icon 21
receiving 62
sending 62

- message waiting indicator 22, 24
- messages menu feature
 - icon 21
- micro-browser, using 69
- microphone 1
- missed call indicator 54
- Missed Calls** message 54
- muting a call 58
- my telephone number 20, 43, 60
- my tones 69

N

- network settings 67
- notepad 54
- number
 - storing your number 43
 - viewing your number 20, 60
- numeric text mode 31

O

- one-touch dial
 - using 56
 - voicemail number 56
- optional accessory, defined 13
- optional feature, defined 13

P

- passwords. *See* codes
- phone
 - active line indicator 23
 - active line, changing 49
 - alert, setting 63
 - alert, turning off 19, 20, 51
 - answer options 44
 - automatic location information 48
 - clear stored information 64
 - codes 41
 - date, setting 43
 - flip 17, 20
 - keypad, answering calls 44
 - language, setting 64
 - location 48
 - locking 40
 - network settings 67
 - reset all options 64
 - security code 41
 - time, setting 43
 - turning on/off 18
 - unlock code 41
 - unlocking 18, 40, 41, 42
- phone number
 - active line indicator 23
 - active line, changing 49
 - adding digits after 53

- phone number (continued)
 - attaching two numbers 53, 55
 - redialing 49
 - storing in phonebook 62
 - storing your number 43
 - viewing your number 20, 60

- phonebook
 - attaching two numbers 53, 55
 - dialing a number 62
 - one-touch dial 56
 - speed dial number 56
 - storing an entry 62
 - voice dialing 62

- picture
 - screen saver 46
 - viewing 69
 - wallpaper 44

- power key 1, 18
- predictive text entry 34

R

- radio 69
- received calls list 52
- recent calls 52
- redial
 - automatic redial 49
 - busy number 49
- reference guide 12
- restricting calls 61

- right soft key
 - functions 1, 22, 26
 - personalizing 63
- ring alert
 - setting 19, 20, 63
 - turning off 19, 20, 51
- ring style
 - personalizing 63
 - setting 43
- ring style indicators 22, 24, 43
- ring tone
 - creating 69
- ringer volume, setting 19, 63
- roam indicator 22, 23

S

- screen saver 46
- security code
 - changing 41
 - default 41
 - forgetting 42
- send key 1, 19, 20, 52
- shortcuts 60, 63
- shortcuts icon 21
- signal strength indicator 22
- silent ring alert, setting 19, 20, 43

- soft keys
 - functions 22, 26
 - illustration 1
 - labels 21
 - personalizing 63
- speakerphone, activating 66
- speed dial
 - number, defined 56
 - using 56
- standby time, increasing 39, 46, 47
- status light 1, 39
- storing a call 52
- symbol chart 38
- symbol text entry 38

T

- tap method text entry 31
- telephone number
 - storing your number 43
 - viewing your number 20, 60
- text
 - block cursor 30, 33
 - browse mode 31
 - character chart 34
 - entering 31
 - entry mode, changing 31
 - flashing cursor 30, 33

- iTAP software predictive text entry 34
- numeric mode 31
- symbol chart 38
- symbol mode 38
- tap method 31
- text entry mode indicator 24
- text mode, changing 31
- three-way call 61
- time, setting 43
- timers 65
- travel charger 15
- TTY device 61

U

- unlock
 - application 69
 - phone 40
- unlock code
 - bypassing 42
 - changing 41
 - default 18, 41
 - entering 18, 40, 41
 - forgetting 42

V

- vibrate alert
 - setting 63
 - turning off 19, 20, 51
- vibrate ring alert, setting 43
- voice dial 62

- voice key
 - dialing a number 62
 - illustration 1
- voice message waiting
 - indicator 57
- voice notes 68
- voicemail
 - dialing with one-touch dial
 - 56
 - using 57
- volume
 - earpiece 19
 - keypad 63
 - ringer 19, 63
- volume keys 1, 19

W

- wallpaper 44
- warranty 77
- Web browser icon 21
- Web pages 69

Z

- zooming in/out 47



MOTOROLA

Wireless Phone Safety Tips

“Safety is your most important call!”

Your Motorola wireless telephone gives you the powerful ability to communicate by voice—almost anywhere, anytime, wherever wireless phone service is available and safe conditions allow. But an important responsibility accompanies the benefits of wireless phones, one that every user must uphold.

When driving a car, driving is your first responsibility. If you find it necessary to use your wireless phone while behind the wheel of a car, practice good common sense and remember the following tips:

- 1 Get to know your Motorola wireless phone and its features such as speed dial and redial.** If available, these features help you to place your call without taking your attention off the road.



- 2 **When available, use a hands-free device.** If possible, add an additional layer of convenience to your wireless phone with one of the many Motorola Original™ hands-free accessories available today.
- 3 **Position your wireless phone within easy reach.** Be able to access your wireless phone without removing your eyes from the road. If you receive an incoming call at an inconvenient time, if possible, let your voice mail answer it for you.
- 4 **Let the person you are speaking with know you are driving; if necessary, suspend the call in heavy traffic or hazardous weather conditions.** Rain, sleet, snow, ice, and even heavy traffic can be hazardous.
- 5 **If you receive an incoming call at an inconvenient time do not take notes or look up phone numbers while driving.** Jotting down a “to do” list or going through your address book takes attention away from your primary responsibility—driving safely.
- 6 **Dial sensibly and assess the traffic; if possible, place calls when you are not moving or before pulling into traffic.** Try to plan calls when your car will be stationary. If you need to make a call while moving, dial only a few numbers, check the road and your mirrors, then continue.
- 7 **Do not engage in stressful or emotional conversations that may be distracting.** Make people you are talking with aware you are driving and suspend conversations which have the potential to divert your attention away from the road.



- 8 Use your wireless phone to call for help.** Dial 9-1-1 or other local emergency number in the case of fire, traffic accident or medical emergencies.*
- 9 Use your wireless phone to help others in emergencies.** If you see an auto accident, crime in progress or other serious emergency where lives are in danger, call 9-1-1 or other local emergency number, as you would want others to do for you.*
- 10 Call roadside assistance or a special non-emergency wireless assistance number when necessary.** If you see a broken-down vehicle posing no serious hazard, a broken traffic signal, a minor traffic accident where no one appears injured, or a vehicle you know to be stolen, call roadside assistance or other special non-emergency wireless number.*

* Wherever wireless phone service is available.

Check the laws and regulations on the use of wireless telephones and their accessories in the areas where you drive. Always obey them. The use of these devices may be prohibited or restricted in certain areas.



For more information,
please call
1-888-901-SAFE
or visit the
CTIA Web site at
www.wow-com.comTM



motorola.com

8988485L61-O