



## USER GUIDE

---

A downloadable, printable guide to your phone's features.

ALCATEL  
onetouch®  
*Cincha™*

# Table of Contents

---

Get Started .....	1
Your Phone at a Glance .....	1
Set Up Your Phone .....	1
Insert the Battery .....	1
Charge the Battery .....	2
Set Up Voicemail .....	3
Phone Basics .....	4
Your Phone's Layout .....	4
Turn Your Phone On and Off .....	5
Lock/Unlock Your Phone .....	5
Navigate Through the Menus .....	5
Status Bar and Notification Panel .....	6
Enter Text .....	7
Phone Calls .....	9
Make Phone Calls .....	9
Call Using the Phone Dialer .....	9
Call from Recent History .....	9
Call from Contacts .....	9
Call Using a Speed Dial Number .....	10
Call Emergency Numbers .....	10
Receive Phone Calls .....	10
Answer an Incoming Call .....	10
Mute the Ringing Sound .....	10
Reject an Incoming Call .....	11
Voicemail .....	11
Voicemail Setup .....	11
Voicemail Notification .....	11
Retrieve Your Voicemail Messages .....	11
Phone Call Options .....	12
In-call Options .....	12
Caller ID .....	13
Conference Calling .....	13
Recent History .....	13

Contacts .....	15
View Contacts .....	15
Contacts List Options .....	15
Add a Contact .....	15
Create a Group .....	17
Save a Phone Number .....	18
Edit a Contact .....	19
Add or Edit Information for a Contact .....	19
Assign a Ringtone to a Contact .....	19
Delete a Contact .....	19
Remove a Member from a Group .....	19
Assign a Speed Dial Number to a Contact .....	19
Messaging .....	21
Send a Text Message .....	21
Save and Resume a Draft Message .....	21
New Messages Notification .....	21
Manage Message Conversations .....	21
Web & Data .....	23
Launch a Web Connection .....	23
Learn to Navigate the Browser .....	23
Adjust Browser Settings .....	23
Tools .....	25
Calendar .....	25
Add an Event to the Calendar .....	25
View an Event .....	25
Edit/Delete an Event .....	25
Event Reminders .....	25
Alarm .....	25
Calculator .....	26
Bluetooth .....	26
Settings .....	27
Display .....	27
Volume .....	27
Ringtones .....	27
Keyguard .....	28
Phone Information .....	28

Lock Phone .....	28
Location .....	29
Parental Controls .....	29
Reset/Delete .....	29
Others .....	29
Accessibility .....	29
Abbreviated Dialing .....	30
Call Answer .....	30
Voice Privacy .....	30
Text Entry .....	30
Airplane Mode .....	31
Data .....	31
Contact Match .....	31
Roaming .....	31
Persistent Alerts .....	31
Language .....	31
Navigation Keys .....	31
For Assistance .....	32
Regulatory Information .....	32
Specific Absorption Rates (SAR) for Wireless Phones .....	32
FCC Radio Frequency Emission .....	32
Using Your Phone with a Hearing Aid Device .....	32
Warning Statements .....	34
Index .....	35

# Get Started

---

Congratulations on receiving your ALCATEL ONETOUCH Cinch. This guide will help you set up and get the most out of your new phone.

## Your Phone at a Glance

The following illustration outlines your phone's primary external features and keys.

**Note:** Your phone's home screen and layouts are subject to change. The user guide uses sample images only.

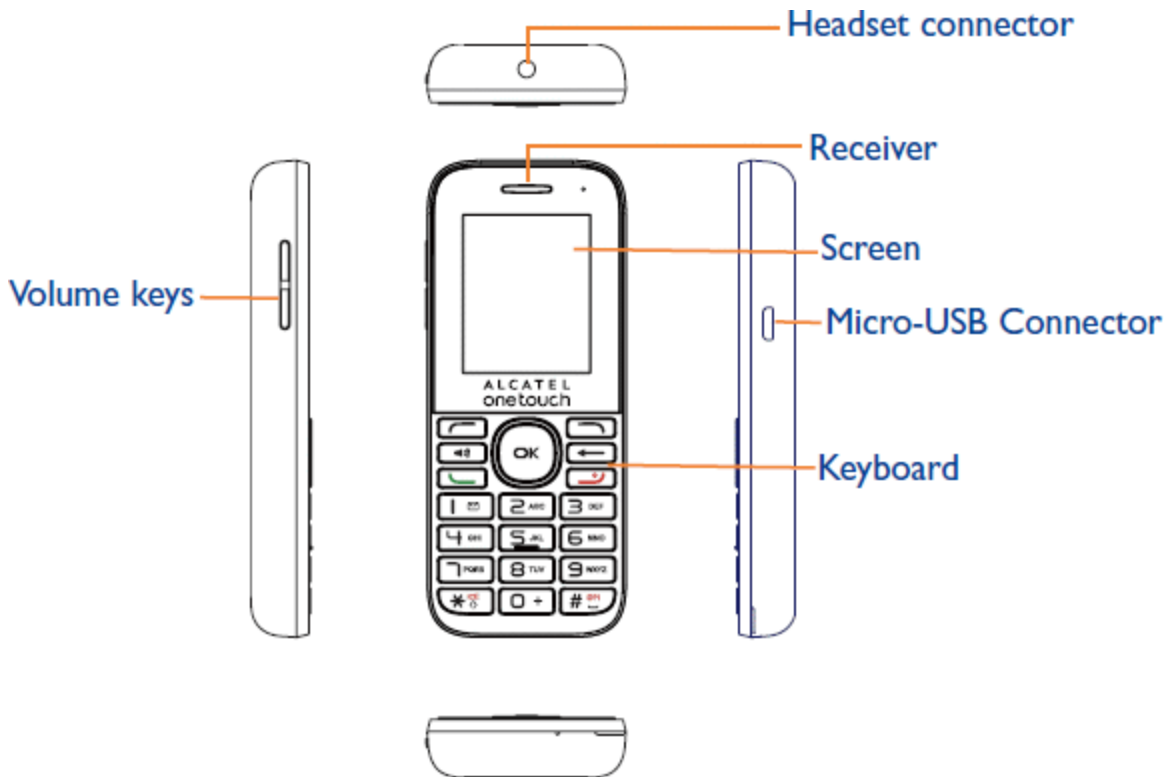

**CAUTION!** Inserting an accessory into the incorrect jack may damage the phone.

## Set Up Your Phone

The following topics will help you set up your phone and wireless service the first time.

### Insert the Battery

Follow these instructions to insert your phone's battery safely and properly.

1. Remove the battery cover.

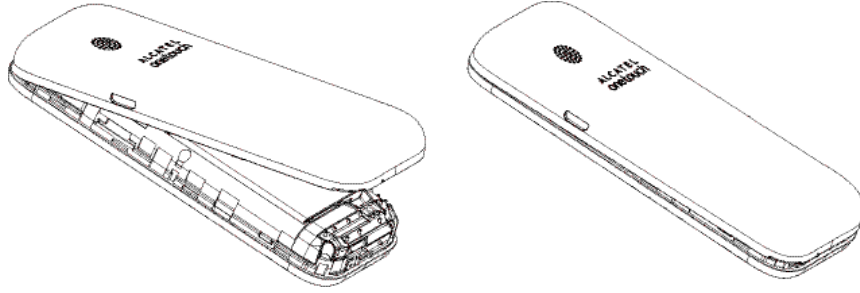

2. Insert the battery.

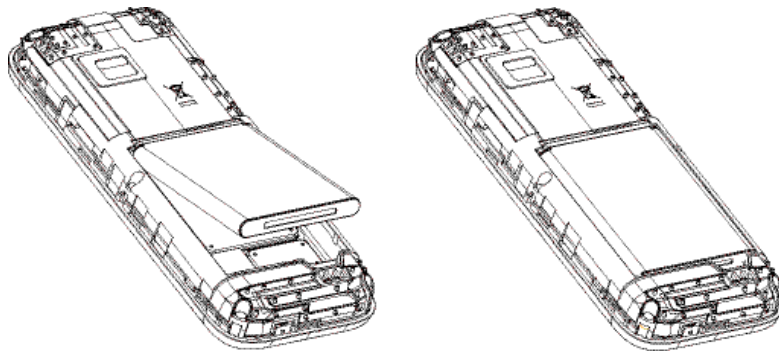

3. Attach the battery cover.

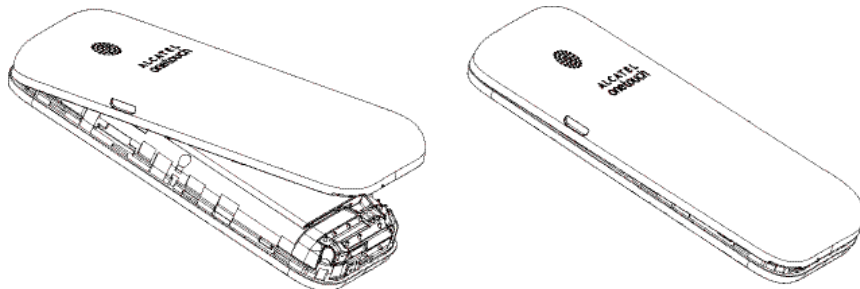

**Note:** Make sure all the tabs are secure and there are no gaps around the cover.

## Charge the Battery

Follow these instructions to charge your phone's battery.

1. Plug the USB connector into the charger/accessory jack on the right side of your phone.



2. Plug the other end of the USB cable into the AC adapter.
3. Plug the AC adapter into an electrical outlet.
4. After charging, disconnect the phone from the charger.

**Note:** You should fully charge the battery as soon as possible. Fully charging the battery may take up to 2 hours.

## Set Up Voicemail

You should set up your voicemail and personal greeting as soon as your phone is activated. Always use a password to protect against unauthorized access. Your phone automatically transfers all unanswered calls to your voicemail, even if your phone is in use or turned off.

1. From the Home screen, press **MENU** (left softkey) > **Messaging** > **Voicemail** > **Call Voicemail**.
2. Follow the system prompts to:
  - Create your password.
  - Record your name announcement.
  - Record your greeting.

**Important: Voicemail Password** – It is strongly recommended that you create a password when setting up your voicemail to protect against unauthorized access. Without a password, anyone who has access to your phone is able to access your voicemail messages.

# Phone Basics

Your phone is packed with features that simplify your life and expand your ability to stay connected to the people and information that are important to you. The following topics will introduce the basic functions and features of your phone.

## Your Phone's Layout

The illustrations and descriptions below outline your phone's basic layout.

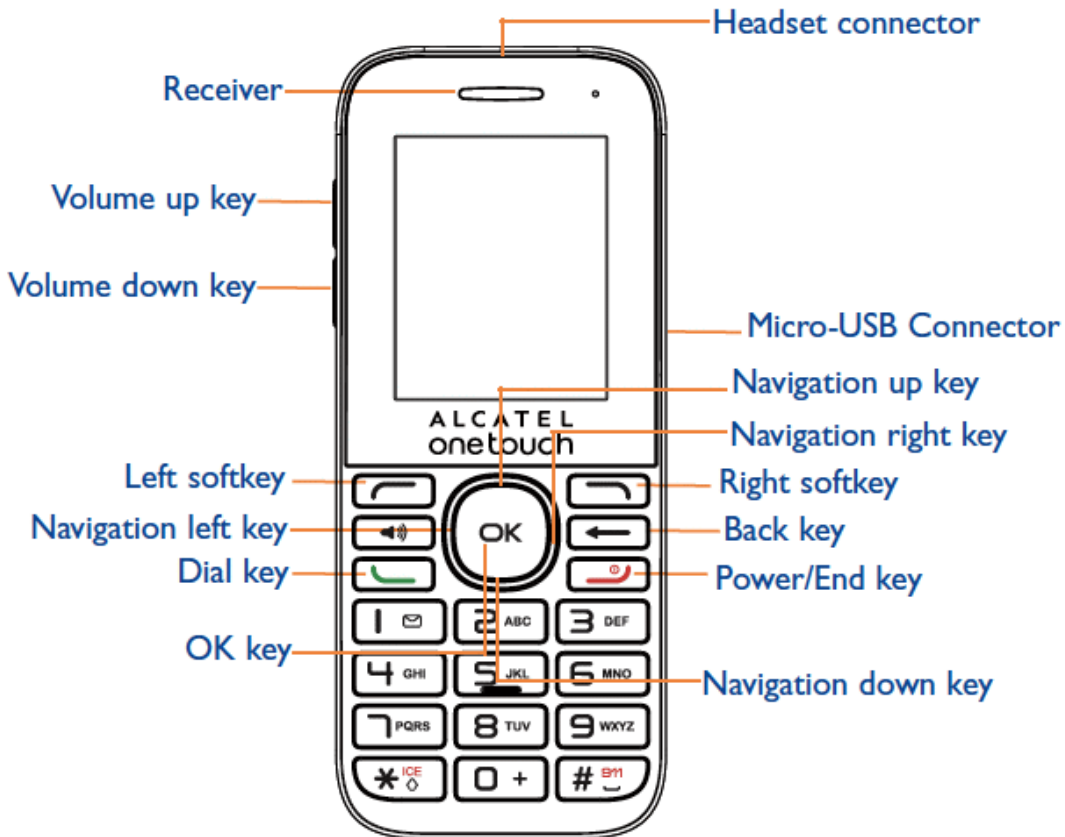

Part	Description
<b>Receiver</b>	Allows you to hear the caller and automated prompts.
<b>Headset connector</b>	Allows you to plug in a headset for convenience, hands-free conversations.
<b>Volume down key</b>	Allows you to increase the ringtone or media volume or adjust the voice volume during a call.
<b>Micro-USB Connector</b>	Allows you to connect the phone charger or the USB cable.
<b>Navigation up key</b>	Press to go up to view an item or confirm an option.



Part	Description
Navigation down key	Press to go down to view an item or confirm an option.
Navigation left key	Press to go left to view an item or confirm an option.
Navigation right key	Press to go right to view an item or confirm an option.
Left softkey	Enter Menu list from the Home screen, view an item or confirm an option.
Right softkey	Enter Contacts from the Home screen, view an item or confirm an option.
Dial key	View recent call history from the Home screen, or dial the number.
Power/End key 	Turn on/off the phone, or return back to the Home screen.

**CAUTION!** Inserting an accessory into the incorrect jack may damage the phone.

## Turn Your Phone On and Off



The instructions below explain how to turn your phone on and off.

- Press and hold the **Power/End key** .

**Note:** Your screen remains blank while the phone is off (unless the battery is charging).

## Lock/Unlock Your Phone

You can prevent accidental screen touches from activating phone functions by locking your phone.

- To lock the phone, press and hold the **Back key** .
- To unlock the phone, press the **OK key** and then press **Back** .



## Navigate Through the Menus

The navigation keys on your phone let you scroll through onscreen items. To navigate a menu, press up or down using the navigation keys.

### Select Menu Items

As you navigate through the menu, menu options are highlighted. Select any option by highlighting it and pressing the **OK key** . If the option is numbered, you can select it by pressing the corresponding number on the phone's keypad.

### Back Up Within a Menu

- To go to the previous menu, press **Back** .
- To return to the Home screen, press **Power/End key** .

# Status Bar and Notification Panel

Your phone's status and notifications are available at a glance at the top of the screen.







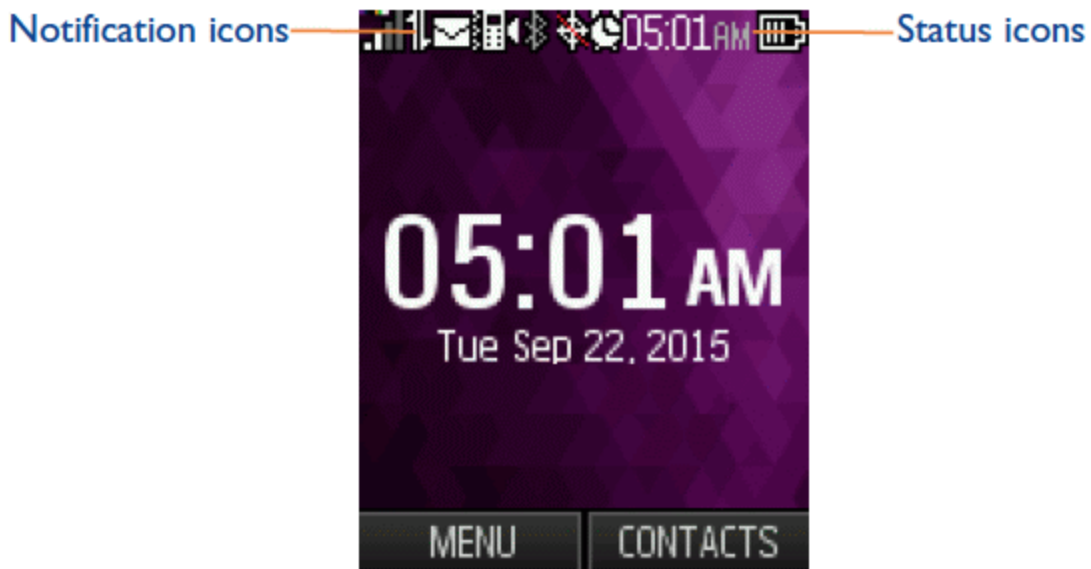

## Status Bar





The status bar at the top of the Home screen provides phone and service status information on the right side and notification alerts on the left.

## Status Bar Layout







## Main Status Icons

Icon	Status
	Bluetooth
	Airplane mode
	Earphones
	Location on
	Location off
	Vibrate
	Silent
	Ringtone off

Icon	Status
	Network (full signal)
	Network (no signal)
	Alarm set
	Battery (charging)
	Battery (full charged)

### Main Notification Icons

Icon	Notification
	Missed call
	New message
	New voicemail
	Event

## Enter Text

You can type on your phone using the keypad.

### Keypad

Your phone provides a convenient keypad to enter letters, numbers, and symbols whenever you are prompted to enter text.

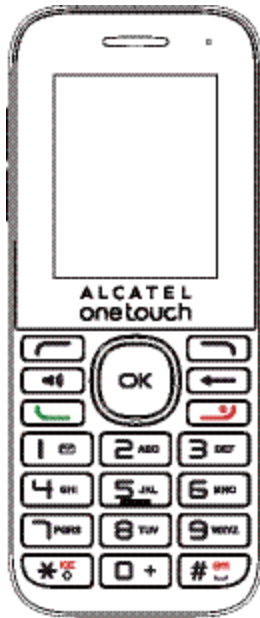

1. From a screen where you can enter text, press  to change the text mode.
2. Select one of the following options:
  - **Abc** to enter characters by using the alphabet mode.
  - **123** to enter numeric characters.
  - **Symbols** to enter symbols.
  - **Smileys** to enter smile icons.

Number Key	Function
1	1, commonly-used symbols
2	a, b, c, A, B, C, 2
3	d, e, f, D, E, F, 3
4	G, h, I, G, H, I, 4
5	j, k, l, J, K, L, 5
6	m, n, o, M, N, O, 6
7	p, q, r, s, P, Q, R, S, 7
8	T, u, v, T, U, V, 8
9	w, x, y, z, W, X, Y, Z, 9
0	0
*	*, change input methods
#	#, insert a space

# Phone Calls

---

With wireless service and your phone's calling features, you can enjoy clear phone calls across the country.

## Make Phone Calls

There are several convenient ways to place calls from your phone.

### Call Using the Phone Dialer

The most "traditional" way to place a call is by using the phone's dial pad.

1. Press the number keys on the dial pad to enter the phone number.
2. Press  to call the number.

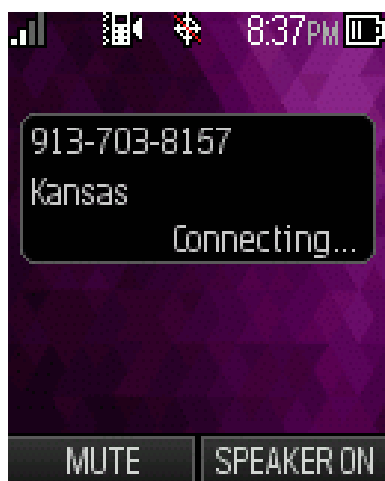

3. To end the call, press .

### Call from Recent History

The Recent History menu lets you quickly place calls to recent incoming, outgoing, or missed numbers.

1. From the Home screen, press  to display the call history.
2. Select the number, and press  again to place a call.

### Call from Contacts

You can place phone calls directly from entries in your Contacts list.

1. From the Home screen, press **CONTACTS** (right softkey) to display the Contacts list.
2. Highlight a contact and then press  to place a call.

## Call Using a Speed Dial Number

Speed dial numbers let you dial numbers by pressing and holding a single number on the dial pad. You can store up to 99 numbers in your phone's speed dial memory to make contacting friends and family easier.

You must have already assigned a speed dial number to an existing phone number.

- From the Home screen, enter the speed dial number, and then press  to place a call.

## Call Emergency Numbers

You can place calls to 9-1-1 even if the phone's screen is locked or your account is restricted.

- From the dial pad, press "9-1-1" and then press .

### Enhanced 9-1-1 (E 9-1-1) Information

This phone features an embedded Global Positioning System (GPS) chip necessary for utilizing E 9-1-1 emergency location services where available.

When you place an emergency 9-1-1 call, the GPS feature of your phone seeks information to calculate your approximate location. Depending on several variables, including availability and access to satellite signals, it may take up to 60 seconds or more to determine and report your approximate location.

**Important:** Always report your location to the 9-1-1 operator when placing an emergency call. Some designated emergency call takers, known as Public Safety Answering Points (PSAPs), may not be equipped to receive GPS location information from your phone.

## Receive Phone Calls

The following information lets you know how to answer incoming calls, mute the ringer on incoming calls, reject incoming calls, and more.

When you receive a phone call from a contact, the Incoming call screen appears and displays the caller name, and phone number of the calling party. When you receive a phone call from someone who is not stored, only the phone number appear on the Incoming call screen.

**Note:** If your phone is turned off, all calls automatically go to voicemail.

### Answer an Incoming Call

Press the **Menu/OK** key  to answer the call.

### Mute the Ringing Sound

To mute the ringer without rejecting the call, press the **Volume** key.

## Reject an Incoming Call

Press the **Power/End** key  to reject an incoming call and send the caller to voicemail.

### Reject a Call and Send a Text Message

You can reject an incoming call and automatically send a text message to the caller.

- Press **Ignore with Text Message** to ignore the call and send a text message to the caller.

## Voicemail

The following topics outline your phone's voicemail service.

### Voicemail Setup

You should set up your voicemail and personal greeting as soon as your phone is activated.

- For information on setting up your voicemail, see [Set Up Voicemail](#).

### Voicemail Notification

There are a couple of different ways your phone alerts you to a new voicemail message.

- By sounding the assigned ringer type.
- By displaying within the Notifications area of the Status bar when a single new unheard voicemail message is received.

**Note:** When you are off network, you may not receive notifications of new voicemail messages. It is recommended that you periodically check your voicemail by dialing 1 + area code + your wireless phone number.

**Note:** Your phone accepts messages even when it is turned off. However, your phone notifies you of new messages only when it is turned on and you are in a network service area.

### Retrieve Your Voicemail Messages

You can review your messages directly from your wireless phone (using either traditional voicemail) or from any other press-tone phone.

#### Use Traditional Voicemail to Access Your Messages

1. Press and hold . If prompted, enter your voicemail password.
2. Follow the voice prompts to listen to and manage your voicemail messages.

## Use Another Phone to Access Messages

1. Dial your wireless phone number.
2. When your voicemail answers, press the asterisk key on the phone (\*).
3. Enter your password.

**Tip:** You can restore messages you have sent to the trash folder.

## Phone Call Options

Your phone application provides many useful features and options to help you make the most of your calling experience.

### In-call Options

While you're on a call, you will see a number of onscreen options. Select a feature by pressing the corresponding keypad number or highlight the option and then press .

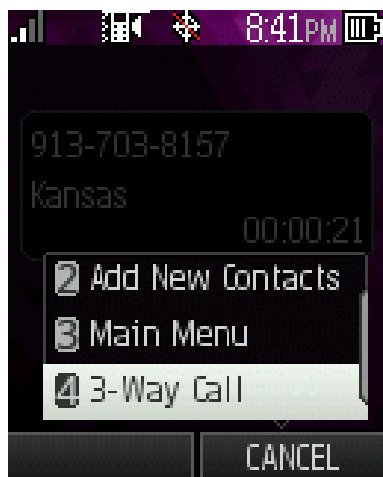

- **Speaker On:** Route the phone's audio through the speaker (On) or through the earpiece (Off).
  - **Activate Speaker** to route the phone's audio through the speaker. (You can adjust the speaker volume using the volume buttons.)
  - **Deactivate Speaker** to use the phone's earpiece.
- **Mute:** Mute the microphone during an active call. Press again to unmute the microphone.
- **Contact Details:** View detailed information of the incoming number.
- **Main Menu:** Display the main menu list.



- **3-Way Call:** Initiate a 3-way conference call.
- **Contacts:** Display your contacts list.
- **Voice Memo:** Create a new memo while remaining on the call.

**Warning:** Because of higher volume levels, do not place the phone near your ear while using speakerphone.

## Caller ID

Caller ID identifies a caller before you answer the phone by displaying the number of the incoming call.

## Conference Calling

With conference calling, also known as 3-way calling, you can talk to two people at the same time. When using this feature, the normal airtime rates will be charged for each of the two calls.

1. On the Phone screen, enter a number and press  (or place a call from Recent History or Contacts).
2. Once you have established the connection, press **OPTIONS** (right softkey) > **3-Way Call**, and then dial the second number (or place the call from Recent History or Contacts).
  - This puts the first caller on hold and dials the second number.
3. Press **TALK** to join calls. Your conference call is now in session.





4. To end the three-way call, press **End** .

**Note:** If one of the people you called hangs up during your call, you and the remaining caller stay connected. If you initiated the call and are the first to hang up, all callers are disconnected.

## Recent History

The Recent History lists all recent incoming, outgoing, and missed calls.

## View Recent History

- From the Home screen, press , or press  and then select **Call History**.

## Recent History Options

- To make a call from the call log, select the number and press  again.

For additional options, press **OPTIONS** (right softkey):

- New group
- Contact details/Save Contact
- Delete
- Delete All

# Contacts

---

Your phone's Contacts help you stay in touch with family, friends, and colleagues by keeping track of all their contact information. The following topics explain how to use your phone's Contacts.

**Personal Contacts Entries** – Entries for an individual.

- Your phone can store up to 600 personal Contacts entries. Each entry can contain up to 7 phone numbers, and 3 email addresses, 3 IM addresses, and 3 Web addresses.

**Group Contacts Entries** – Entries that contain more than one personal Contacts entry.

- Your phone can store up to 25 Group Contacts entries. Each group entry can contain up to 40 members.

## View Contacts

You can view and create contacts on your phone.

To access Contacts:

- From the Home screen, press **CONTACTS** (right softkey).

– or –

From the Home screen, press  > **Go to Contacts**.

- **Contacts List:** The Contacts list displays all contacts currently stored in your phone.
- **Add New:** Press to add a new contact or new group.

## Contacts List Options

From contact list you can find various options listed below.

- **Send Msg:** Send a message to your contacts(s).
- **New Group:** Create a new group for your contacts.
- **Edit Contact:** Edit contact information.
- **Delete Contact:** Delete the contact you select.
- **Delete All:** Delete all contacts in the list.

## Add a Contact

You can add contacts to enter details such as name, phone numbers, email addresses, mailing addresses, and more.

1. From the Home screen, press **CONTACTS** (right softkey) > **Add New** > **New Contact**.

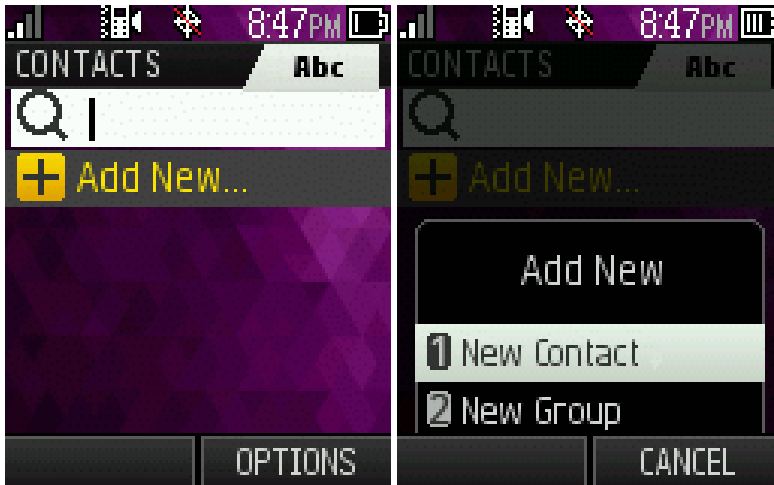

2. Use the keypad to enter contact information you want, including:

- Name
- Phone Number
- Email Address
- IM
- URL
- Location
- Ringtone
- Birthday
- Memo
- Job Title
- Company

3. Press **DONE** (left softkey) to save your new contact.

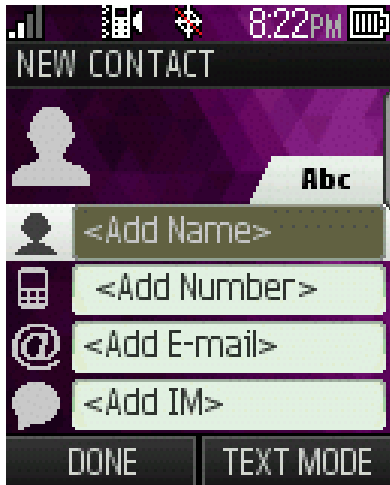

## Create a Group

You can create a group by assigning personal Contacts entries as members and then naming the new group. Each group entry can contain up to 40 members for sending messages.

1. From the Home screen, press **CONTACTS** (right softkey) > **OPTIONS** (right softkey) > **New Group**.

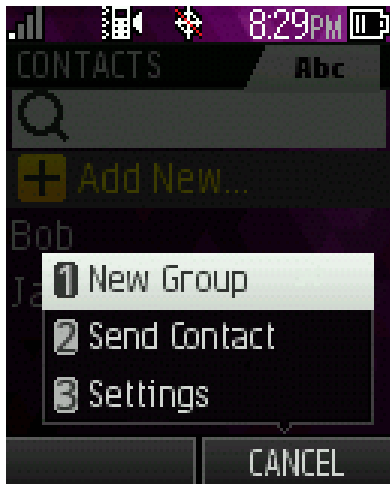

2. Press **START** (left softkey). Use the  key to checkboxes to select contacts for the group and then press **CONTINUE** (left softkey).

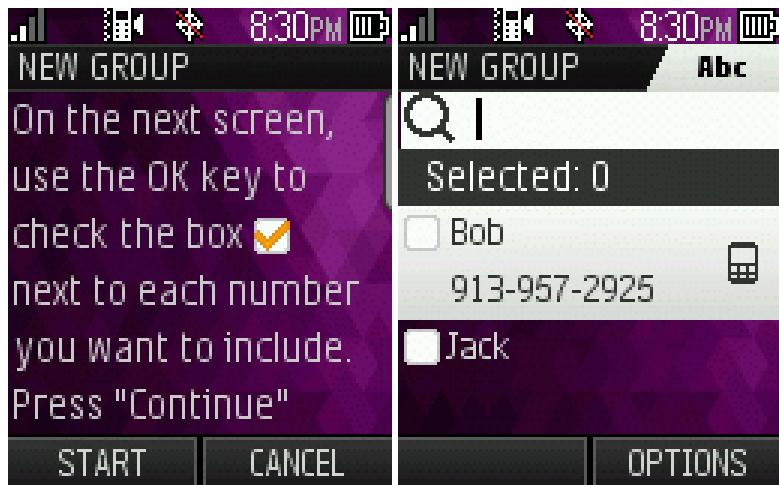

3. Create a name for the group and then press **SAVE** (left softkey) to save.

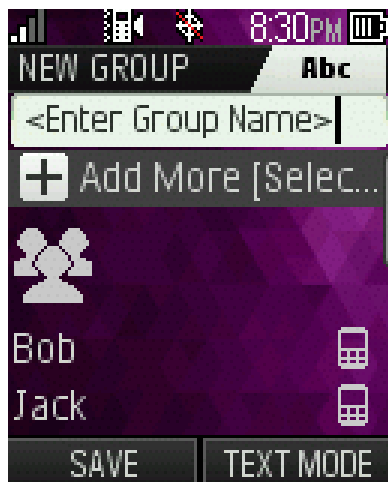

## Save a Phone Number

You can save a phone number to Contacts directly from Recent History or Call History.

1. From the Home screen, press .
2. Highlight a phone number and press **OPTIONS** (left softkey) > **Save Contact**.
3. For a new contact, enter the name and any additional information, and then press **Done**.

## Edit a Contact

Once you've added a contact, you can add or edit any of the information in the entry, customize with a unique ringtone, and more.

### Add or Edit Information for a Contact

Use the Edit contact menu to add or edit information for an existing contact.

1. From the Home screen, press **CONTACTS** (right softkey).
2. Select a contact to display it, and then press **OPTIONS** (right softkey) > **Edit Contact**.
3. Add or edit information and then press **DONE** (left softkey).

### Assign a Ringtone to a Contact

Know who's calling without looking at your phone by assigning a specific ringer to a contact.

1. From the Home screen, press **CONTACTS** (right softkey).
2. Select a contact to display it, and then press **OPTIONS** (right softkey) > **Edit Contact**.
3. Highlight and select the **Ringtone** field then select an available ringtone.
4. Press **PLAY** (left softkey) to hear a sample.
5. Press and then press **DONE** (left softkey) to assign the ringtone.

### Delete a Contact

You can delete a contact from the contacts details page.

1. From the Home screen, press **CONTACTS** (right softkey).
2. Press a contact to display it, and then press **OPTIONS** (right softkey) > **Delete Contact**.
3. Press **DELETE** (left softkey) to confirm.

### Remove a Member from a Group

You can remove a member from a current Group.

1. From the Home screen, press **CONTACTS** (right softkey).
2. Highlight a group and then press **OPTIONS** (right softkey) > **Edit Group**.
3. Highlight a contact and then press **OPTIONS** (right softkey) > **Remove from group** > **YES** (left softkey).

### Assign a Speed Dial Number to a Contact

Your phone can store up to 99 phone numbers in speed dial locations.

To assign a speed dial number:

1. From the Home screen, press **CONTACTS** (right softkey).
2. Press **OPTIONS** (right softkey) > **Settings** > **Speed Numbers**.
3. Enter or select a number to assign the speed dial location.
4. Select a contact to be added to the speed dial location.

**Note:** If you assign a number to an already in-use speed dial location, the new phone number will automatically replace the previously assigned speed dial.



# Messaging

---

With Text Messaging (SMS), you can send and receive instant text messages between your wireless phone and another messaging-ready phone.

## Send a Text Message

Quickly compose and send text messages from your phone.

1. From the Home screen, press **MENU** (left softkey) > **Messaging**.
2. Select **Send Message**.
3. To enter a recipient, select **Go to Contacts** or press **NEW ADDRESS** (right softkey).
  - To enter multiple recipients, press **MULTIPLE** (left softkey). When you have selected all the message recipients, press **CONTINUE** (left softkey).
4. Compose your message.

**Note:** A counter appears above the **SEND** button to tell you how many characters you have entered and how many characters are left. Once you go over the 160-character limit, a new message is created but automatically joined into one when received.

5. Review your message and then press **SEND** (left softkey) to send the text message.

## Save and Resume a Draft Message

A Message can be saved or resumed after composing.

- While composing a text message, press **OPTIONS** (right softkey) > **Save As Draft** to automatically save your message as a draft.

## New Messages Notification

Depending on your notification settings, the phone will play a ringtone, vibrate, or display the message briefly in the status bar when you receive a new text message.

## Manage Message Conversations

Text messages that are sent to and received from a contact (or a number) are grouped into conversations or message threads in the Messaging screen. Threaded text let you see exchanged messages (similar to a chat program) with a contact on the screen.

### Read a Text Message

1. From the Home screen, press **MENU** (left softkey) > **Messaging** > **Messages**.
2. Select the text message or message thread to open and read it.
3. To return to the Messaging screen from a text message thread, press the **BACK** key .

### Reply to a Message

1. From the Home screen, press **MENU** (left softkey) > **Messaging** > **Messages**.
2. Select a text message thread to open it.
3. Press **REPLY** (left softkey), enter your content, and then press **SEND** (left softkey).

### Delete a Message Thread

1. From the Home screen, press **MENU** (left softkey) > **Messaging** > **Messages**.
2. Highlight the message thread that you want to delete.
3. Press **OPTIONS** (right softkey) > **Delete Message**.
4. When prompted to confirm, press **YES** (left softkey).

### Delete Multiple Message Threads

1. From the Home screen, press **MENU** (left softkey) > **Messaging** > **Messages**.
2. Press **OPTIONS** (right softkey) > **Delete Multiple**.
3. Mark the checkboxes to select the message threads you want to delete or press **SELECT ALL** (right softkey).
4. Press **DONE** (left softkey). When prompted to confirm, press **YES** (left softkey).

### Delete a Single Message

1. While viewing a message thread, select the message that you want to delete.
2. Press **OPTIONS** (right softkey) > **Delete**.
3. When prompted to confirm, press **YES** (left softkey).

# Web & Data

---

Your phone's data capabilities let you wirelessly access the Internet. The following topics address your phone's data connections and the built-in Web browser. Your phone supports a 1X RTT network.

## Launch a Web Connection

Launching a Web connection is as simple as opening the browser on your phone.

1. From the home screen, press **MENU** (left softkey) > **Web**. (Your data connection starts and you see the home page.)
2. To scroll through the screen, use the **Up** and **Down Navigation** keys.
3. To exit the Web at any time, simply press .

**Note:** The Browser automatically launches when a Web link is selected from a text message.

## Learn to Navigate the Browser

Navigating through menus and websites during a data session is easy once you have learned a few basics.

- To scroll through Web items, press the **Up** and **Down Navigation** keys.
- To access the Web menu list, press **Navigation** (left softkey).
- To return to the previous page, press **Navigation** (left softkey) and then select the **Back** button.
- To move to the next page, press **Navigation** (left softkey) and then select the **Forward** button.

Options available within the browser menu include:

- **Bookmarks:** Use bookmarks when you want to leave a page and visit it later.
- **Browsing history:** Display recently accessed pages.
- **Add this page to Bookmarks:** Add the current page to your Bookmarks.
- **Send this page to a friend:** Send the current page address to a friend via text message.

## Adjust Browser Settings

You can control many of the settings for your browser through the browser settings menu.

- From any open Web page, press **Options** (right softkey) > **Browser settings**.
  - **Startup page:** Set startup page.
  - **Automatic Overview Mode:** Turn on/off Automatic Overview Mode.
  - **Default zoom size:** Select automatic or customized zoom value.

- **Do not show images/Show images:** Display or hide images on the Web page.
- **Icon row:** Display or hide the area showing icons.
- **Popups:** Allow or block popups.
- **Clear private data:** Clear cookies, cache, history, or stored passwords.
- **Advanced:** View more settings such as page information, browser information, disable JavaScript, etc.

# Tools

---

Learn how to use many of your phone's productivity-enhancing features.

## Calendar

Use Calendar to create and manage events, meetings, and appointments. Your Calendar helps organize your time and reminds you of important events.

### Add an Event to the Calendar

Add events to your calendar directly from the Calendar application.

1. From the Home screen, press **MENU** (left softkey) > **Tools** > **Calendar**.
2. Press **OPTIONS** (right softkey) > **Add New Event**.
3. Fill in all required information for this new event.
4. When done, press **SAVE** (left softkey) to save.

### View an Event

View detailed information about your Calendar events.

1. From the Home screen, press **MENU** (left softkey) > **Tools** > **Calendar**.
2. Select a date that has an event.
3. Select an event to view details.

### Edit/Delete an Event

Use Calendar to edit or delete an existing event.

1. From the Home screen, press **MENU** (left softkey) > **Tools** > **Calendar**.
2. Select a date that has an event.
3. To edit an event, select the event and then press **EDIT** (right softkey); to delete the event, press **DELETE** (left softkey).

### Event Reminders

If you have set at least one reminder for an event, the upcoming event icon  will appear.

- Select **View Now** or **Dismiss**.

## Alarm

Set multiple alarms using your phone's Alarm Clock app.

1. From the Home screen, press **MENU** (left softkey) > **Tools** > **Alarm**.
2. If you haven't created any alarm, press **CREATE NEW** (left softkey).
3. Fill in all required information for this alarm.
4. When done, press **DONE** (left softkey).

## Calculator

Your phone's convenient built-in calculator lets you perform basic mathematical equations.

- From the Home screen, press **MENU** (left softkey) > **Tools** > **Calculator**.
  - Enter a number, select the type of operation to be performed using the Navigation keys, and enter the second number, and then press the  key to display the result.
  - Once an operation is complete, you can select **CLEAR** (right softkey) to clear numbers and carry out a new operation.

## Bluetooth

Bluetooth is a short-range communications technology that allows you to connect wirelessly to a number of Bluetooth devices, such as headsets and hands-free car kits, and Bluetooth-enabled handhelds, computers, printers. The Bluetooth communication range is usually approximately 30 feet.

### Turn Bluetooth On or Off

Bluetooth can be turned on and off from the Tools menu.

- From the Home screen, press **MENU** (left softkey) > **Tools** > **Bluetooth**.

To pair and use your phone with a Bluetooth-enabled device:

1. From the Home screen, press **MENU** (left softkey) > **Tools** > **Bluetooth** > **Add New**.
2. Select the device you wish to pair with and press  > **YES**.
3. (Optional) Edit the device name and then press **SAVE** (left softkey).

**Note:** Turn off Bluetooth when not in use to conserve battery power.

# Settings

---

The following topics provide an overview of items you can change using your phone's Settings menus.

## Display

Adjusting your phone's display settings not only helps you see what you want, it can also help increase battery life.

### Access Display Settings

1. From the Home screen, press **MENU** (left softkey) > **Settings** > **Display**.
2. Select a settings category to customize your display settings.
  - **Wallpaper**: Select and assign your phone's background wallpaper.
  - **Picture ID**: Select an image for contacts, unsaved numbers and private/unknown numbers.
  - **Backlight Control**: Set backlight and backlight dim intervals.
  - **Brightness**: Set brightness degree.
  - **Font Size**: Select font size.
  - **Power Save Mode**: Turn on/off Power Save Mode.
  - **Greeting**: Set greeting screen.

## Volume

Set your phone's ringtone, keypress sound and key beeps.

### Access Display Settings

1. From the Home screen, press **MENU** (left softkey) > **Settings** > **Volume**.
2. Select a settings category to customize your volume settings.
  - **Incoming Ringer Volume**: Adjust incoming ringtone volume.
  - **Playback Volume**: Select playback ringtone.
  - **Key Beeps**: Adjust keep beeps volume.

## Ringtones

Set the ringtone of calls, voicemail, messages, power up/down sound and battery alert.

## Access Ringtones Settings

1. From the Home screen, press **MENU** (left softkey) > **Settings** > **Ringtones**.
2. Select a settings category to customize your ringtone settings.
  - **Incoming Calls:** Select ringtones for current contacts, unsaved numbers, private/unknown numbers.
  - **Voicemail:** Select ringtones for voicemail notification.
  - **Messages:** Select ringtones for messages notification.
  - **Power Up/Down:** Activate/deactivate Power Up/Down sound.
  - **Battery Alert:** Activate/deactivate battery alert sound.

## Keyguard

You can lock the keyboard when not using it.

1. From the Home screen, press **MENU** (left softkey) > **Settings** > **Keyguard**.
2. Turn on/off keyguard function.

## Phone Information

You can access detailed information about your phone's memory, battery, and version.

### Access Phone Information Settings

1. From the Home screen, press **MENU** (left softkey) > **Settings** > **Phone Information**.
2. Select a category to view detailed information.
  - **Phone Number/User ID:** View the phone number, MSID, software version, hardware version, etc.
  - **Memory:** View internal memory.
  - **Battery:** View current battery percentage.
  - **Icon Glossary:** View status icons and notifications icons glossary.
  - **Version:** View OS, model, hardware version, software version, etc.
  - **Advanced:** Have advanced information of the phone such as SID, Channel, Technology, etc.

## Lock Phone

Lock phone settings let you protect your phone and data from unauthorized access. It is recommended you frequently change your password to ensure the safety of your phone and personal data.



1. From the Home screen, press **MENU** (left softkey) > **Settings** > **Lock Phone**.
2. Enter security code with 4 digits.

## Location

Use your Location settings menu to enable location detection.

1. From the Home screen, press **MENU** (left softkey) > **Settings** > **Location**.
2. Select **On** to allow the network to detect your position using GPS.

**Note:** Turning location off will disable the GPS capability of your phone for all purposes except 9-1-1. GPS support for E 9-1-1 service is not available in all areas.

## Parental Controls

Parents can restrict functions on the phone.

1. From the Home screen, press **MENU** (left softkey) > **Settings** > **Parental Controls**.
2. Enter security code with 4 digits to turn on Parental Controls.
3. Select the restricted functions that are not suitable for children.

## Reset/Delete

Your phone's reset menu erases all data from the phone's application storage, including messages, phones calls, downloaded application, etc.

1. From the Home screen, press **MENU** (left softkey) > **Settings** > **Reset/Delete**.
2. Enter security code with 4 digits.

## Others

The Others menu allows you to configure additional settings related to accessibility, calling, text entry, data, and more.

### Accessibility

The Accessibility menu lets you enable and manage accessibility-related applications. To access the menu, follow below instructions:

1. From the Home screen, press **MENU** (left softkey) > **Settings** > **Others** > **Accessibility**.
2. Select a settings category to view and set.
  - **Voice Guide:** Turn on/off speech output and set speech rate.
  - **TTY:** Press to select TTY mode or turn off TTY.
  - **Hearing AID:** Turn on hearing aid to reduce unacceptable noise.

- **Font Size:** Select font size.
- **Keypad Vibrate:** Activate/deactivate vibration while pressing the keypad.
- **Color Inversion:** Activate/deactivate Color Inversion.

## Abbreviated Dialing

The Abbreviated Dialing menu allows you to activate/deactivate the speed dial function.

1. From the Home screen, press **MENU** (left softkey) > **Settings** > **Others** > **Abbreviated Dialing**.
2. Activate and customize the speed dial function.

## Call Answer

Allows you to select any key or only talk key to answer a call.

1. From the Home screen, press **MENU** (left softkey) > **Settings** > **Others** > **Call Answer**.
2. Select any key or only talk key to answer a call.

## Voice Privacy

The Voice Privacy feature allows you to you encrypt voice communication.

1. From the Home screen, press **MENU** (left softkey) > **Settings** > **Others** > **Voice Privacy**.
2. Activate/deactivate the Voice Privacy feature.

## Text Entry

Text Entry settings enable more options when entering text.

1. From the Home screen, press **MENU** (left softkey) > **Settings** > **Others** > **Text Entry**.
2. Select a settings category to view and set.
  - **Auto-Capital:** Automatically capitalize the first letter of the first word after a period, the first word in a text field, and each word in name fields.
  - **Auto-Space:** Automatically insert a space.
  - **Predictive Language:** Change the languages.
  - **Personal Dictionary:** Touch to open a list of the words you've added to the dictionary.
  - **Word Choice List:** Turn on/odd word choice list.
  - **Word Prediction:** Turn on/off the functions on showing the predictive word.
  - **Word Completion:** Automatically complete the word spelling.
  - **Use My Words:** Use the stored or created from your side.
  - **Help:** Get more information about text entry from the website.

## Airplane Mode

Airplane Mode allows you to use many of your phone's features, when you are on an airplane or in any other area where making or receiving calls or data is prohibited. When you set your phone to Airplane Mode, it cannot send or receive any calls or access online information.

To turn Airplane Mode on or off:

- From the Home screen, press **MENU** (left softkey) > **Settings** > **Others** > **Airplane Mode**.

## Data

Your phone's data capabilities let you wirelessly access the Internet. Your phone supports a 1X RTT network.

- From the Home screen, press **MENU** (left softkey) > **Settings** > **Others** > **Data**.

## Contact Match

The contact match allows you to find an existing contact by entering the first 4 digits of the number.

- From the Home screen, press **MENU** (left softkey) > **Settings** > **Others** > **Contact Match**.

## Roaming

Enable the roaming function in foreign countries and select the roaming mode.

- From the Home screen, press **MENU** (left softkey) > **Settings** > **Others** > **Roaming**.

## Persistent Alerts

Set a persistent alert as an audible tone, vibration or show on LED.

- From the Home screen, press **MENU** (left softkey) > **Settings** > **Others** > **Persistent Alerts**.

## Language

Select English or Español as the language for your phone.

- From the Home screen, press **MENU** (left softkey) > **Settings** > **Others** > **Language**.

## Navigation Keys

Customize the Navigation keys by assigning specific functions or numbers from contacts.

1. From the Home screen, press **MENU** (left softkey) > **Settings** > **Others** > **Navigation Keys**.
2. Select a settings category to view and set.
3. Change the Up, Down, Left and Right menu options by highlighting the option and pressing .
4. Press **OK** (left softkey) to save the change.

# For Assistance

---

The following topics address areas of support for your phone.

## Regulatory Information

The following topics provide important regulatory information.

### Specific Absorption Rates (SAR) for Wireless Phones

The SAR value corresponds to the relative amount of RF energy absorbed into the head of a user of a wireless handset.

The SAR value of a phone is the result of an extensive testing, measuring and calculation process. It does not represent how much RF the phone emits. All phone models are tested at their highest value in strict laboratory settings. But when in operation, the SAR of a phone can be substantially less than the level reported to the FCC. This is because of a variety of factors including its proximity to a base station antenna, phone design and other factors. What is important to remember is that each phone meets strict federal guidelines. Variations in SARs do not represent a variation in safety.

All phones must meet the federal standard, which incorporates a substantial margin of safety. As stated above, variations in SAR values between different model phones do not mean variations in safety. SAR values at or below the federal standard of 1.6 W/kg are considered safe for use by the public.

The highest reported SAR values of the ALCATEL ONETOUCH Cinch are:

Head: 1.39W/kg (1g)

Body-worn: 1.19 W/kg (1g)

For body-worn operation, this device has been tested and meets the FCC RF exposure guidelines when used with an accessory that contains no metal and that positions the handset a minimum of 15 mm from the user's body.

### FCC Radio Frequency Emission

This phone meets the FCC Radio Frequency Emission Guidelines.

FCC ID number: RAD556

More information on the phone's SAR can be found from the following FCC website:

<http://fcc.gov/oet/ea/>

### Using Your Phone with a Hearing Aid Device

A number of Boost phones have been tested for hearing aid device compatibility. When some wireless phones are used with certain hearing devices (including hearing aids and cochlear implants), users may detect a noise which can interfere with the effectiveness of the hearing device.

Some hearing devices are more immune than others to this interference noise, and phones also vary in the amount of interference noise they may generate. ANSI standard C63.19 was developed to provide a standardized means of measuring both wireless phone and hearing devices to determine usability rating categories for both.

Ratings have been developed for mobile phones to assist hearing device users find phones that may be compatible with their hearing device. Not all phones have been rated for compatibility with hearing devices. Phones that have been rated have a label located on the box. Your ALCATEL ONETOUCH Cinch has an M3/T4 rating.

These ratings are not guarantees. Results will vary depending on the user's hearing device and individual type and degree of hearing loss. If a hearing device is particularly vulnerable to interference noise; even a phone with a higher rating may still cause unacceptable noise levels in the hearing device. Trying out the phone with your hearing device is the best way to evaluate it for your personal needs.

**M-Ratings:** Phones rated M3 or M4 meet FCC requirements for hearing aid compatibility and are likely to generate less interference to hearing devices than unrated phones. (M4 is the better/ higher of the two ratings.)

**T-Ratings:** Phones rated T3 or T4 meet FCC requirements and are likely to be more usable with a hearing device's telecoil ("T Switch" or "Telephone Switch") than unrated phones. (T4 is the better/higher of the two ratings. Note that not all hearing devices have telecoils in them.)

**Note:** New Technologies, Including Wi-Fi. This phone has been tested and rated for use with hearing aids for some of the wireless technologies that it uses. However, there may be newer wireless technologies (including Wi-Fi) used in this phone that have not been tested for use with hearing aids.

Hearing aid devices may also be measured for immunity to interference noise from wireless phones and should have ratings similar to phones. Ask your hearing healthcare professional for the rating of your hearing aid. Add the rating of your hearing aid and your phone to determine probable usability:

- Any combined rating equal to or greater than six offers excellent use.
- Any combined rating equal to five is considered normal use.
- Any combined rating equal to four is considered usable.

Thus, if you pair an M3 hearing aid with an M3 phone, you will have a combined rating of six for "excellent use." This is synonymous for T ratings.

It is further suggested you experiment with multiple phones (even those not labeled M3/T3 or M4/T4) while in the store to find the one that works best with your hearing aid device. Should you experience interference or find the quality of service unsatisfactory after purchasing your phone, promptly return it to the store. More information about hearing aid compatibility may be found at: [fcc.gov](http://fcc.gov), [fda.gov](http://fda.gov), and [accesswireless.org](http://accesswireless.org).

This equipment complies with the hearing aid compatibility technical requirements of Section 20.19 of the rules. HAC Ratings: M3 T4 -2011.

## Warning Statements

THIS DEVICE COMPLIES WITH PART 15 OF THE FCC RULES. OPERATION IS SUBJECT TO THE FOLLOWING TWO CONDITIONS: (1) THIS DEVICE MAY NOT CAUSE HARMFUL INTERFERENCE, AND (2) THIS DEVICE MUST ACCEPT ANY INTERFERENCE RECEIVED, INCLUDING INTERFERENCE THAT MAY CAUSE UNDESIRE OPERATION.

The user manual for an intentional or unintentional radiator shall caution the user that changes or modifications not expressly approved by the party responsible for compliance could void the user's authority to operate the equipment.

**Note:** THE GRANTEE IS NOT RESPONSIBLE FOR ANY CHANGES OR MODIFICATIONS NOT EXPRESSLY APPROVED BY THE PARTY RESPONSIBLE FOR COMPLIANCE. SUCH MODIFICATIONS COULD VOID THE USER'S AUTHORITY TO OPERATE THE EQUIPMENT.

**Note:** This equipment has been tested and found to comply with the limits for a Class B digital device, pursuant to part 15 of the FCC Rules. These limits are designed to provide reasonable protection against harmful interference in a residential installation.

This equipment generates, uses and can radiate radio frequency energy and, if not installed and used in accordance with the instructions, may cause harmful interference to radio communications. However, there is no guarantee that interference will not occur in a particular installation. If this equipment does cause harmful interference to radio or television reception, which can be determined by turning the equipment off and on, the user is encouraged to try to correct the interference by one or more of the following measures:

- Reorient or relocate the receiving antenna.
- Increase the separation between the equipment and receiver.
- Connect the equipment into an outlet on a circuit different from that to which the receiver is connected.
- Consult the dealer or an experienced radio/TV technician for help.

# Index

---

## A

Abbreviated Dialing 30  
Accessibility 29  
Airplane Mode 31  
Alarm 25  
Answer an Incoming Call 10  
Assign a Ringtone to a Contact 19

## B

Bluetooth 26

## C

Calculator 26  
Calendar 25

- Add an Event 25
- Edit/Delete an Event 25
- Event Reminders 25
- View an Event 25

Call Answer 30  
Call Emergency Numbers 10  
Call from Contacts 9  
Call from Recent History 9  
Call Using a Speed Dial Number 10  
Call Using the Phone Dialer 9  
Caller ID 13  
Charge the Battery 2  
Conference Calling 13  
Contact Match 31  
Contacts 15

- Add a Contact 15
- Assign Speed Dial to a Contact 19
- Create a Group 17
- Delete a Contact 19
- Edit a Contact 19
- List Options 15
- Remove Member from Group 19
- Save a Phone Number 18
- View Contacts 15

## D

Data 31  
Display Settings 27

## E

Enter Text 7

## F

For Assistance 32

## G

Get Started 1

## I

In-call Options 12  
Insert the Battery 1

## K

Keyguard 28  
Keypad 7

## L

Language 31  
Location 29  
Lock Phone 28  
Lock/Unlock Your Phone 5

## M

Make Phone Calls 9  
Messages

- Delete a Message Thread 22
- Delete a Single Message 22
- Delete Multiple Message Threads 22
- New Messages Notification 21
- Read a Text Message 21
- Reply to a Message 22
- Save and Resume a Draft Message 21
- Send a Text Message 21

Messaging 21  
Mute the Ringing Sound 10

## N

Navigate Menus 5  
Navigation Keys 31  
Notification Panel 6

	<b>O</b>		<b>Y</b>
Others	29	Your Phone at a Glance	1
	<b>P</b>		
Parental Controls	29		
Persistent Alerts	31		
Phone Basics	4		
Phone Call Options	12		
Phone Calls	9		
Phone Information	28		
Phone Layout	4		
Phone Setup	1		
	<b>R</b>		
Receive Phone Calls	10		
Recent History	13		
Regulatory Information	32		
Reject an Incoming Call	11		
Reset/Delete	29		
Ringtones	27		
Roaming	31		
	<b>S</b>		
Settings	27		
Status Bar	6		
	<b>T</b>		
Text Entry	30		
Tools	25		
Turn Your Phone On and Off	5		
	<b>V</b>		
Voice Privacy	30		
Voicemail	11		
Notification	11		
Retrieve Messages	11		
Setup	11		
Voicemail Setup	3		
Volume Settings	27		
	<b>W</b>		
Web & Data	23		
Browser Settings	23		
Launch a Web Connection	23		
Navigate the Browser	23		